

PLEATED BLIND SYSTEMS

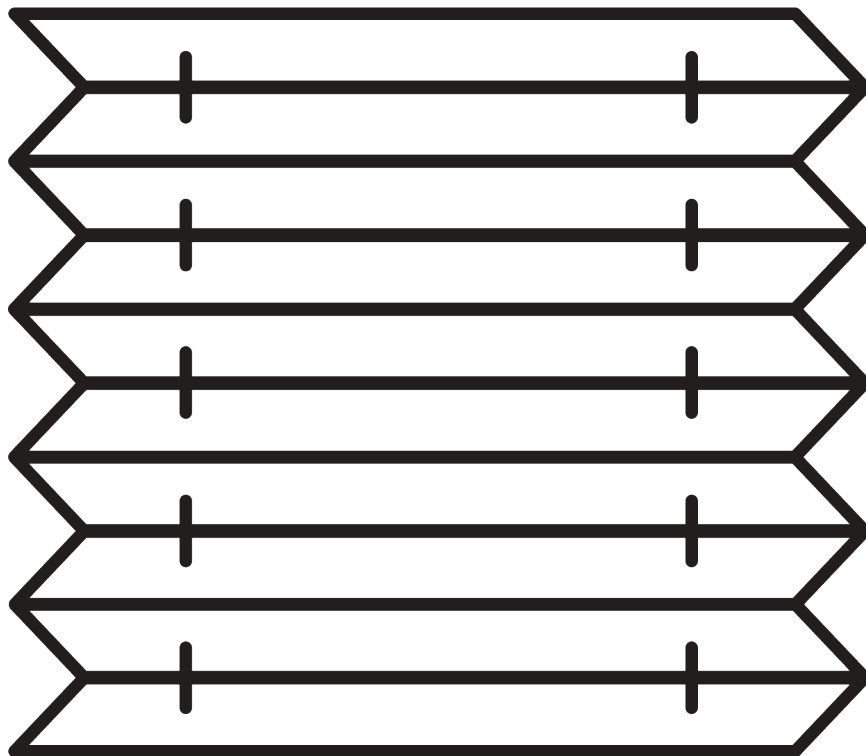

GENERAL NOTES

Dimensions

- *Measurements are in mm except where indicated.*

Fitting

- *Installation by qualified fitter only.*
- *Number of brackets and fitting positions / fixing points vary depending on fitting surface, system weight, fabric type, screw / fixing type and obstacles.*
- *Qualified fitter must use appropriate screws / fixings for each situation.*
- *Profile lip if applicable to be installed to room side.*
- *Electrical installations must be carried out according to Silent Gliss wiring diagrams and conform to local regulations.*
- *Check space for cables and plugs!*

Child Safety

- *All relevant Silent Gliss systems correspond to child safety EN 13120.*
- *All parties involved must comply with EN 13120.*

SG 8500

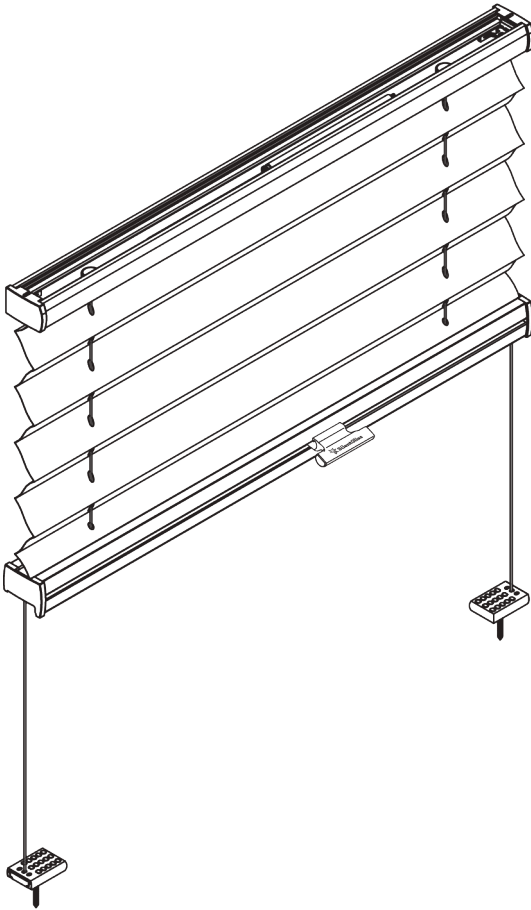
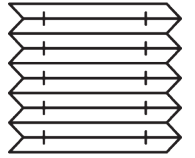

PRODUCT INFORMATION

- **Operation:** handle, chain, cord, crank, motorised
- **Range:** S - M
- **Fitting:** ceiling, wall, recess
- **Colours:** white, grey, anthracite, brushed aluminum, special colours possible
- **Fabrics:** refer to Silent Gliss pleated blind collection

Features:

- Versatile application options (including skylights, winter gardens)
- Different shapes
- Small stacking dimensions for limited space

OVERVIEW

Model name
explanation

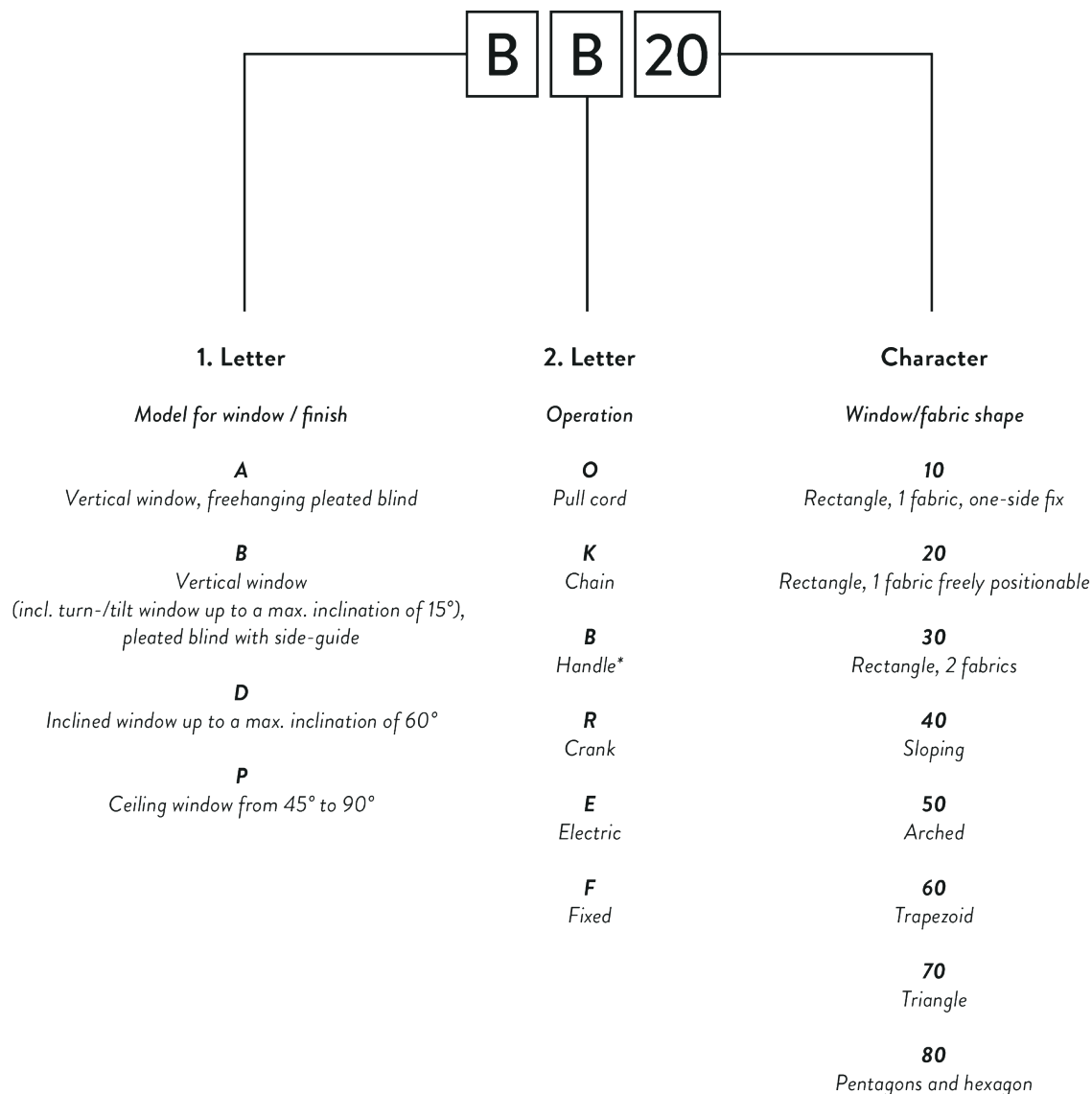

* Standard: metal operating handle
Optional: plastic operating handle,
(required when optional control
wand selected)

A. BLIND TYPES

Vertical windows

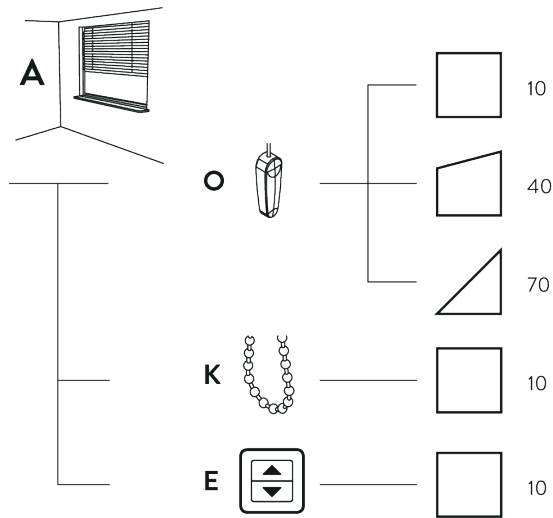

Blind type A

- For vertical windows
- Rectangular areas as well as special shapes
- Freehanging pleated blinds (without side guides)
- Various operation options

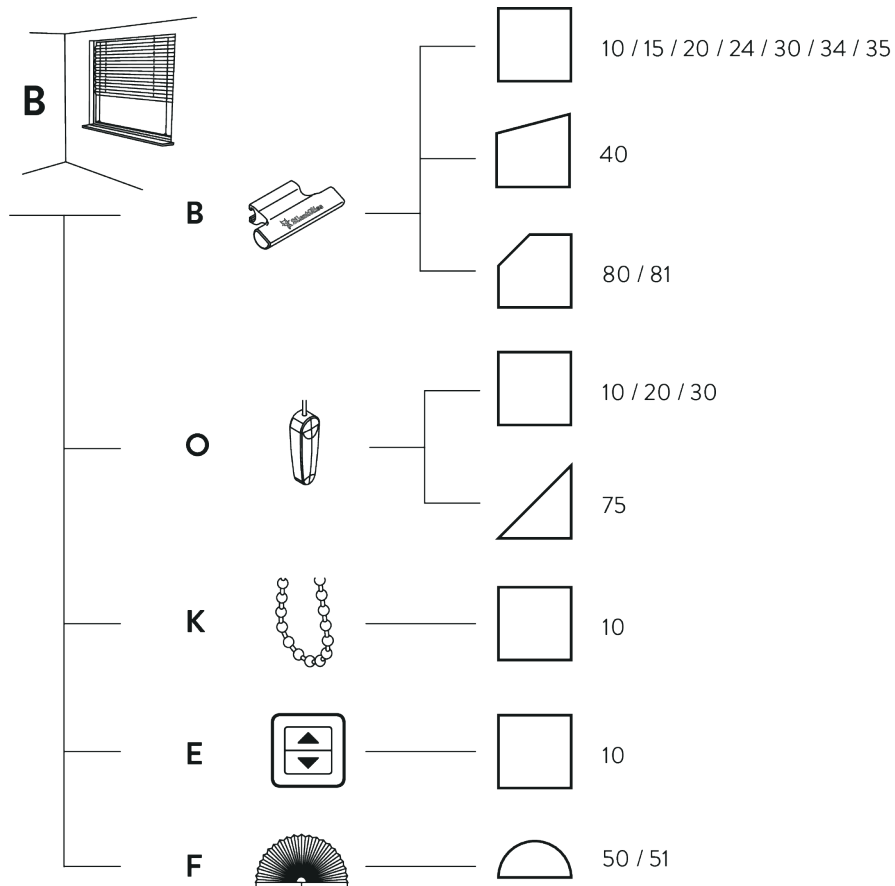

Blind type B

- For vertical windows (up to max. inclination of 15°)
- Rectangular areas as well as special shapes
- Pleated blinds with side guides
- Various operation options

Roof and pivot windows

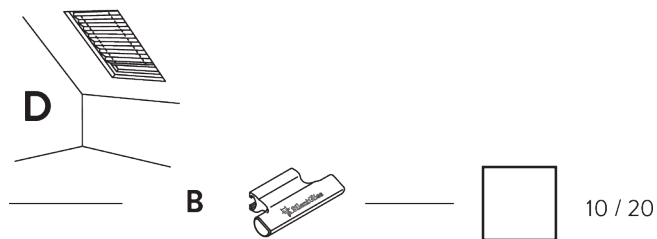

Blind type D

- Roof and pivot windows up to a max. inclination of 60°
- Only rectangular areas
- Pleated blinds with side guides
- Operation by handle

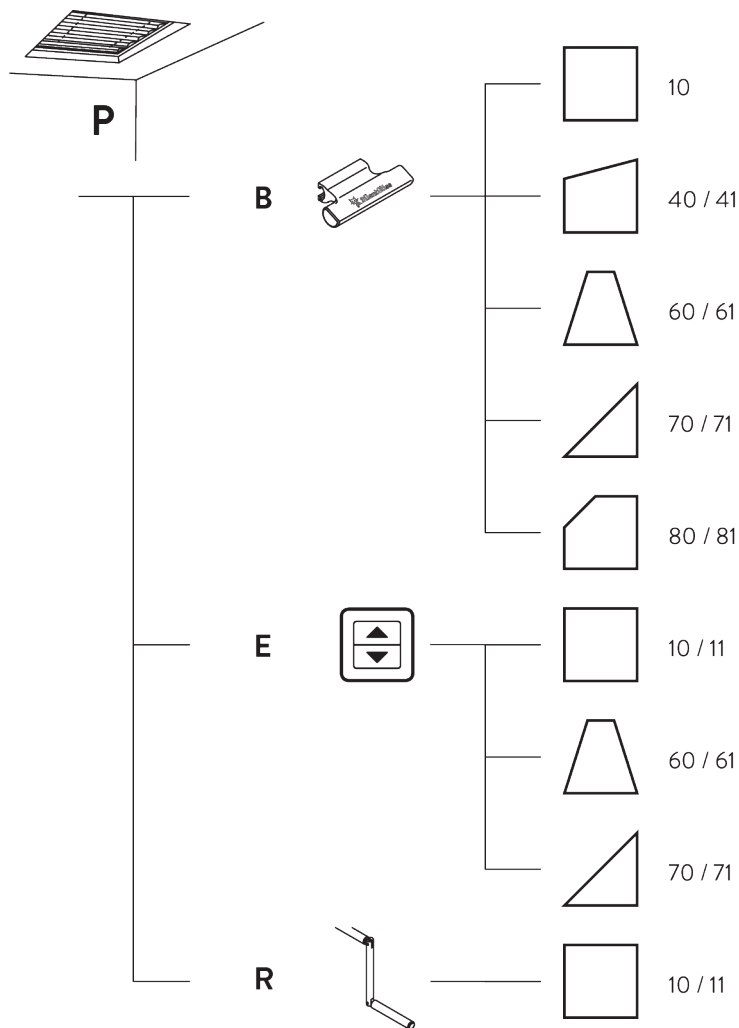

Blind type P

- For ceiling windows, skylights, wintergardens, etc.
- For an inclination between 45° and 90° (=horizontal)
- Rectangular areas as well as special shapes
- Pleated blinds with permanent steel wire tensioning
- Various operation options

DIMENSIONS / FITTING

A. FITTING INFORMATION

For detailed fitting information, visit the Silent Gliss website.

Dimensions Pleated Blind Types

| Pleated Blind Type | Min. width (cm) | Max. width (cm) | Min. top width (cm) | Min. bottom width (cm) | Difference max. (cm) | Min. height (cm) | Max. height (cm) | Surface max. (m ²) | Min. angle | Max. angle |
|--------------------|-----------------------|-------------------|---------------------|------------------------|----------------------|------------------|-------------------|--------------------------------|------------|-------------------|
| AE10 | 51 / 41 ^{C)} | 220 | | | | 10 | 250 | | | |
| AK10 | 50 | 220 | | | | 50 | 250 | | | |
| AO10 | 40 | 220 | | | | 10 | 250 | | | |
| AO40 | | 210 | | 40 | | 10 | 250 | 5 ^{B)} | | 50° |
| AO70 | | 210 | | 40 | | 10 | 180 | | | 60° ^{D)} |
| BB10 | 15 | 150 ^{A)} | | | | 10 | 220 | | | |
| BB15 | 15 | 150 ^{A)} | | | | 10 | 220 | | | |
| BB20 | 15 | 150 ^{A)} | | | | 10 | 220 | | | |
| BB24 | 25 | 150 ^{A)} | | | | 10 | 220 | 3 | | |
| BB30 | 25 | 150 ^{A)} | | | | 30 | 220 | 3 | | |
| BB34 | 25 | 128 ^{A)} | | | | 30 | 220 | 2.5 | | |
| BB35 | 25 | 150 ^{A)} | | | | 30 | 220 | 3 | | |
| BB40 | | 128 | | 30 | | 30 | 220 | 2.5 | | 50° |
| BB80 | | 150 | 12 | 40 | 138 | 30 | 220 | | | |
| BB81 | | 150 | 12 | 50 | 138 | 30 | 220 | | | |
| BE10 | 51 / 41 ^{C)} | 220 | | | | 10 | 250 | | | |
| BF50 | 15 | 60 | | | | 15 | 60 | | | |
| BF51 | 30 | 120 | | | | 15 | 60 | | | |
| BK10 | 50 | 220 | | | | 50 | 250 | | | |
| BO10 | 40 | 220 | | | | 10 | 250 | | | |
| BO20 | 40 | 220 | | | | 10 | 250 | | | |
| BO30 | 40 | 220 | | | | 10 | 250 | 5 ^{B)} | | |
| BO75 | | 210 | 40 | | | 10 | 180 | | 10° | 60° |
| DB10 | 30 | 150 ^{A)} | | | | 10 | 220 | 2.2 | | |
| DB20 | 30 | 150 ^{A)} | | | | 10 | 220 | 2.2 | | |
| PB10 | 20 | 150 | | | | 10 | 450 ^{B)} | ^{B)} | | |
| PB40 | | 100 | 0 | 20 | 100 | 10 | 250 | | | |
| PB41 | | 150 | 0 | 20 | 75 | 10 | 250 | | | |
| PB60 | | 150 | 12 | 20 | 88 | 10 | 250 | | 10° | 89° |
| PB61 | | 150 | 12 | 20 | 69 | 10 | 250 | | 10° | 89° |
| PB70 | | 100 | 0 | 20 | 100 | 10 | 250 | | 10° | 89° |
| PB71 | | 150 | 0 | 20 | 75 | 10 | 250 | | 10° | 89° |
| PB80 | | 100 | 12 | 40 | 88 | 30 | 250 | | | |
| PB81 | | 150 | 12 | 40 | 69 | 30 | 250 | | | |
| PE10 | 26 | 220 | | | | 10 | 450 ^{B)} | 6 ^{B)} | | |
| PE11 | 26 | 220 | | | | 10 | 450 ^{B)} | 6 ^{B)} | | |
| PE60 | | 220 | 12 | 26 | 88 | 10 | 250 | 5 | 10° | 89° |
| PE61 | | 220 | 12 | 26 | 69 | 10 | 250 | 5 | 10° | 89° |
| PE70 | | 100 | 0 | 26 | 100 | 10 | 250 | | 10° | 89° |
| PE71 | | 150 | 0 | 26 | 75 | 10 | 250 | | 10° | 89° |
| PR10 | 20 | 220 | | | | 10 | 450 ^{B)} | 7 ^{B)} | | |
| PR11 | 20 | 220 | | | | 10 | 450 ^{B)} | 7 ^{B)} | | |

A: From a system width of 120 cm and wider, the bottom bar may flex slightly. (No warranty claim!)

B: Please note: the max. system dimensions also depend on the fabric selection

C: Up to a height of 200 cm

D: Up to 50° with cord lock; over 50° without a cord lock

Dimensions DUETTE Blind Types

| DUETTE® Blind Type | Min. width (cm) | Max. width (cm) | Min. top width (cm) | Min. bottom width (cm) | Difference max. (cm) | Min. height (cm) | Max. height (cm) | Surface max. (m ²) | Min. angle | Max. angle |
|-----------------------|-----------------------|--------------------|------------------------|---------------------------|-------------------------|---------------------|---------------------|-----------------------------------|------------|-------------------|
| AE10 | 51 / 41 ^{C)} | 220 | | | | 50 | 250 | B) | | |
| AK10 | 50 | 220 | | | | 50 | 250 | B) | | |
| AO10 | 40 | 220 | | | | 10 | 250 | B) | | |
| AO40 | | 210 | | 40 | | 10 | 250 | 4 B) | | 50° |
| AO70 | | 210 | | 40 | | 10 | 180 | | | 60° ^{D)} |
| BB10 | 15 | 150 ^{A)} | | | | 10 | 220 | B) | | |
| BB15 | 15 | 150 ^{A)} | | | | 10 | 220 | B) | | |
| BB20 | 15 | 150 ^{A)} | | | | 10 | 220 | B) | | |
| BB24 | 25 | 150 ^{A)} | | | | 10 | 220 | 3 B) | | |
| BB30 | 25 | 150 ^{A)} | | | | 30 | 220 | 3 B) | | |
| BB34 | 25 | 128 ^{A)} | | | | 30 | 220 | 2 B) | | |
| BB35 | 25 | 150 ^{A)} | | | | 30 | 220 | 3 B) | | |
| BB40 | | 128 | | 30 | | 30 | 220 | 2.5 B) | | 50° |
| BB80 | | 150 | 12 | 40 | 138 | 30 | 220 | 3 B) | | |
| BB81 | | 150 | 12 | 50 | 138 | 30 | 220 | 3 B) | | |
| BE10 | 51 / 41 ^{C)} | 220 | | | | 10 | 250 | B) | | |
| BF50 | 15 | 60 | | | | 15 | 60 | | | |
| BF51 | 30 | 120 | | | | 15 | 60 | | | |
| BK10 | 50 | 220 | | | | 50 | 250 | B) | | |
| BO10 | 40 | 220 | | | | 10 | 250 | 5 B) | | |
| BO20 | 40 | 220 | | | | 10 | 250 | 5 B) | | |
| BO30 | 40 | 220 | | | | 10 | 250 | 4 B) | | |
| BO75 | | 210 | 40 | | | 10 | 180 | | 10° | 60° |
| DB10 | 30 | 150 ^{A)} | | | | 10 | 220 | 2.2 B) | | |
| DB20 | 30 | 150 ^{A)} | | | | 10 | 220 | 2.2 B) | | |
| PB10 | 20 | 150 | | | | 10 | 400 ^{B)} | B) | | |
| PB40 | | 100 | 0 | 20 | 100 | 10 | 250 | | | |
| PB41 | | 150 | 0 | 20 | 75 | 10 | 250 | | | |
| PB60 | | 150 | 12 | 20 | 88 | 10 | 250 | | 10° | 89° |
| PB61 | | 150 | 12 | 20 | 69 | 10 | 250 | | 10° | 89° |
| PB70 | | 100 | 0 | 20 | 100 | 10 | 250 | | 10° | 89° |
| PB71 | | 150 | 0 | 20 | 75 | 10 | 250 | | 10° | 89° |
| PB80 | | 100 | 12 | 40 | 88 | 30 | 250 | | | |
| PB81 | | 150 | 12 | 40 | 69 | 30 | 250 | | | |
| PE10 | 26 | 220 | | | | 10 | 400 ^{B)} | 5 B) | | |
| PE11 | 26 | 220 | | | | 10 | 400 ^{B)} | 5 B) | | |
| PE60 | | 220 | 12 | 26 | 88 | 10 | 250 | 5 B) | 10° | 89° |
| PE61 | | 220 | 12 | 26 | 69 | 10 | 250 | 5 B) | 10° | 89° |
| PE70 | | 100 | 0 | 26 | 100 | 10 | 250 | | 10° | 89° |
| PE71 | | 150 | 0 | 26 | 75 | 10 | 250 | | 10° | 89° |
| PR10 | 20 | 220 | | | | 10 | 400 ^{B)} | 6 B) | | |
| PR11 | 20 | 220 | | | | 10 | 400 ^{B)} | 6 B) | | |

A: From a system width of 120 cm and wider, the bottom bar may flex slightly. (No warranty claim!)

B: Please note: the max. system dimensions also depend on the fabric selection

C: Up to a height of 200 cm

D: Up to 50° with cord lock; over 50° without a cord lock

General Fitting Information

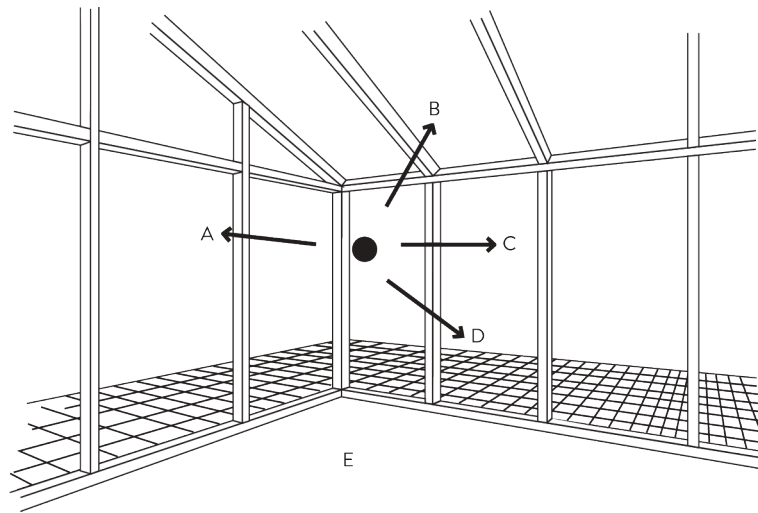

- Please measure the width / height dimensions several times
 - For inside recess fix use the smallest frame measurement.
For outside recess fix measure the size of the actual space
 - Make any necessary deductions
 - Take into account any existing fittings or window furniture when mounting directly onto a frame
- A: Left
 B: Top
 C: Right
 D: Bottom
 E: Room inside

Important note for mounting with clamp brackets for plastic windows (option M4):

When using clamp brackets for plastic windows the width can be measured as desired. Fittings, etc. must be taken into account. For all blind types with side-guides, 2 cm must be subtracted from the wing height to obtain the ordering height. With freehanging models, the ordering height is determined individually. However, at the top 1 cm height deduction must be taken into account.

B. MEASUREMENT

Inside Recess Fix

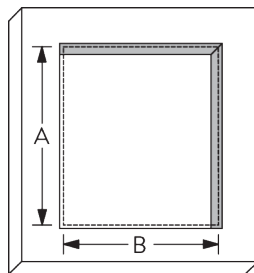

Rectangular shapes

Determine the clear dimensions and make any required deductions (we recommend 0.5 cm in width and height). The measurements given will be used unchanged.

Ordering width B = reveal width minus 0.5 cm
 Ordering width A = reveal height minus 0.5 cm

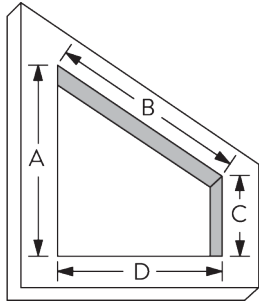

Special shapes

Determine the reveal dimensions (no deductions necessary).
 Deductions will be determined through Silent Gliss.
 Please provide sketch with all measurements!

Ordering widths D / B = clear widths
 Ordering widths A / C = clear heights

Outside Recess Fix

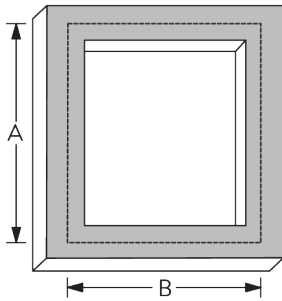

Rectangular shapes

Measure the dimensions and make any allowances, consider any fixtures and fittings.
 The data given will be used unchanged.

Ordering widths B = reveal width plus allowances (left + right)
 Ordering widths A = reveal height plus allowances (top + bottom)

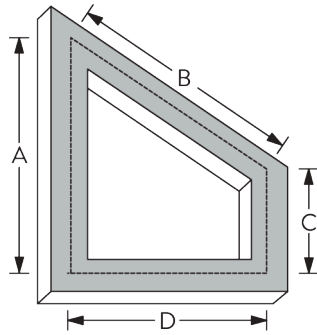

Special shapes

Measure the dimensions considering the overlap each side and any fixtures and fittings. These are the measurements when ordering. Please be aware that the actual width of the blind could be narrower depending on the angle and size of the window. Please provide a drawing with your order.

Ordering widths D / B = determined outside dimensions
 Ordering heights A / C = determined outside dimensions

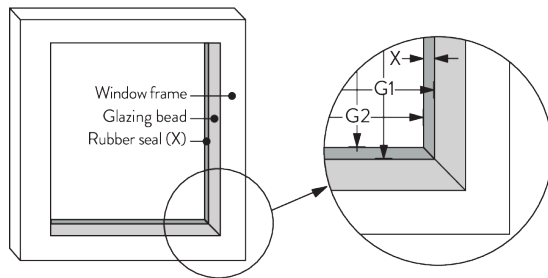

Self-adhesive installation profiles (O7)

Measure the dimensions and make any allowances, consider any fixtures and fittings.
 The data given will be used unchanged.

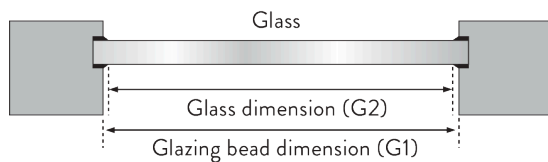

Glazing bead straight

If rubber seal (X) = less than 0.5 cm

Ordering widths / ordering heights = glazing bead dimension (G1) - 0.3 cm

If rubber seal (X) = greater than 0.5 cm

Ordering widths / ordering heights = glazing bead dimension (G2) + 0.7 cm

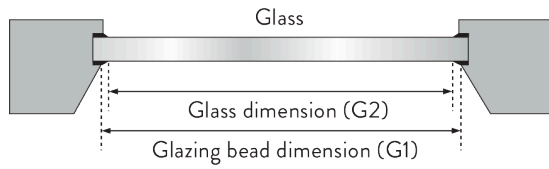

Glazing bead sloped

If rubber seal (X) = less than 0.5 cm

Ordering widths / ordering heights = glazing bead dimension (G1) - 0.1 cm

If rubber seal (X) = greater than 0.5 cm

Ordering widths / ordering heights = glazing bead dimension (G2) + 0.7 cm

**C. INSIDE RECESS
FIX / OUTSIDE
RECESS FIX**

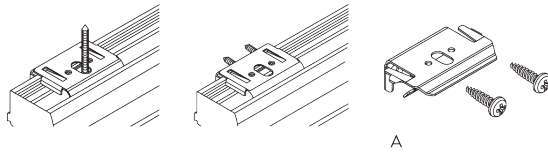

Universal bracket

A: Universal bracket incl. screws

D. FITTING OPTIONS

Support bracket (M1-M3)

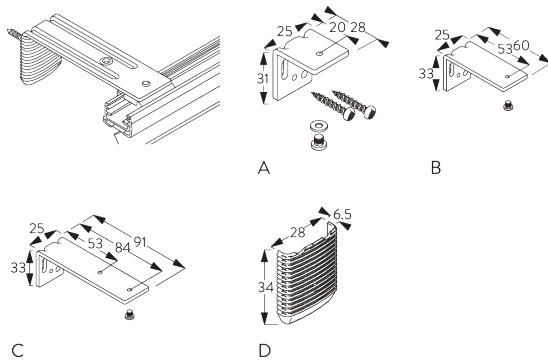

A: Support bracket 28 mm (M1) incl. screws

B: Support bracket 60 mm (M2) incl. screws

C: Support bracket 91 mm (M3) incl. screws

D: Cover for support bracket

**Fitting with clamp
bracket (M4)**

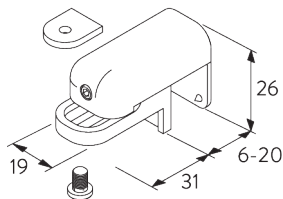

Clamp bracket for plastic windows

**Installation with
glazing bead support
(M5)**

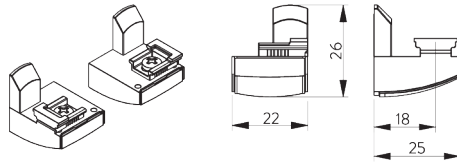

Glass bead support incl. screws for blind type BB24 / BB34 up to a width of max. 128 cm.

**Installation in glazing
bead (M6)**

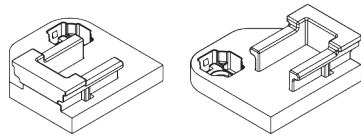

Min. 9 mm straight support surface for blind type BB24 / BB34 up to a width of max. 128 cm.

E. SYSTEM OPTIONS

**Additional finishing
profile (O1)**

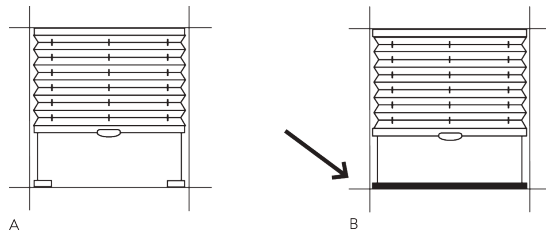

A: Standard
B: with finishing profile

Applicable for all rectangular B and D blind types.

**Additional side-guide
profiles (O2 / O3)**

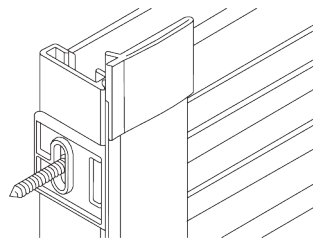

L-Form (O2)

For glazing beads 90° or 96°.
Suitable for all rectangular models (excl. models with cord or chain operation).
P models up to a height of max. 150 cm.
Side guide profiles can only be ordered at the same time as the system and cannot be retrofitted.

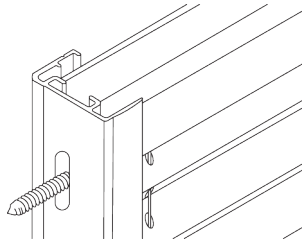

U-Form (O3)

For glazing beads 90°.

Suitable for all rectangular models (excl. models with chain, crank or electric operation).

P models up to a height of max. 150 cm.

Side guide profiles can only be ordered at the same time as the system and cannot be retrofitted.

Mounting profile and accessories (O4)

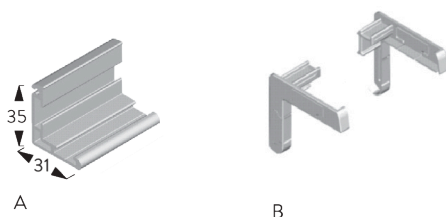

A

B

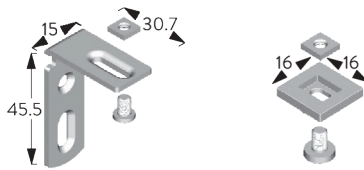

C

D

A: Mounting profile

B: End cover for mounting profile

C: Bracket for mounting profile

D: Connecting screw

Self-adhesive installation profiles (O7)

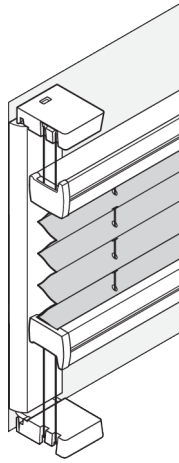

Installation of the system directly on the glass, without any drilling or screwing. The retaining strips are glued to the window pane, then the brackets are attached.
Applicable with blind type BB24 / BB34 up to a width of max. 128 cm.

Control wands / Crank

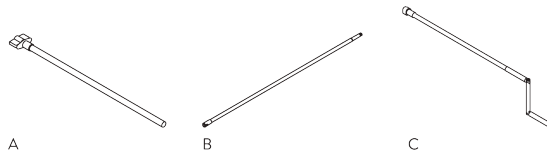

Blind types with plastic operating handle

A: Control wand 301000075, made-to-measure up to max. 200 cm

B: Control wand 201210365, extendable 160-300 cm

Blind types with crank

C: Crank 301000077, made-to-measure up to max. 300 cm

PLEATED BLIND TYPES

A. VERTICAL WINDOWS / RECTANGULAR SHAPES

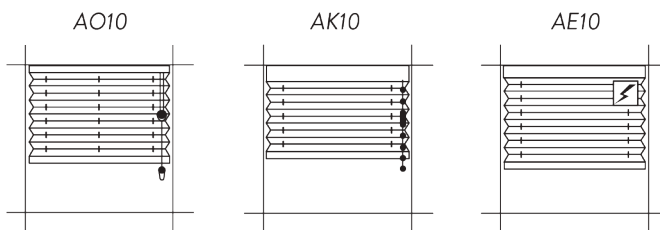

| | | | |
|-------------------|--------------------------|---|---|
| Standard fitting: | Top / Inside recess fix | Top / Inside recess fix | Top / Inside recess fix |
| Fitting options: | M1 / M2 / M3 / M4 | M1 / M2 / M3 / M4 | M1 / M2 / M3 / M4 |
| System options: | O3 | - | O2 |
| Operation: | Pull cord with cord lock | Chain with safety retainer. Gear in headrail (34 mm) | Electric. Motor (24 V DC) in headrail (34 mm) |
| Stacking: | Top stack | Top stack | Top stack |

- Pleated blinds freehanging
- Attention! Please note the minimum and maximum measurement restrictions in the tables on pages 6 / 7!

B. VERTICAL WINDOWS / SPECIAL SHAPES

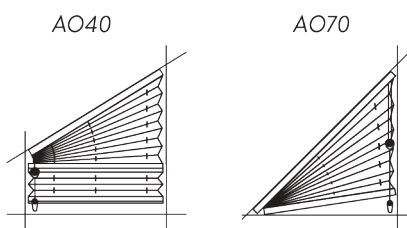

| | | |
|-------------------|---|---|
| Standard fitting: | Top / Inside recess fix | Top / Inside recess fix |
| Fitting options: | M1 / M2 / M3 | M1 / M2 / M3 |
| System options: | - | - |
| Operation: | Pull cord with cord lock, only smaller height | Pull cord with cord lock, only greater height |
| Stacking: | Top stack, raising to the slope | Top stack, raising to the slope |

- Pleated blinds freehanging
- Attention! Please note the minimum and maximum measurement restrictions in the tables on pages 6 / 7!

**C. VERTICAL
WINDOWS UP TO
15° INCLINATION /
RECTANGULAR
SHAPES**

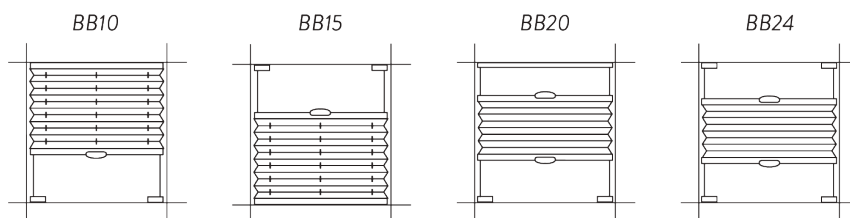

| | | | | |
|-------------------|--|--|--|---|
| Standard fitting: | Top / Inside recess fix | Top / Inside recess fix | Top / Inside recess fix | Top / Inside recess fix |
| Fitting options: | M1 / M2 / M3 / M4 | M1 / M2 / M3 / M4 | M1 / M2 / M3 / M4 | M1 / M2 / M3 / M4 / M5 / M6 |
| System options: | O1 / O2 / O3 | O2 / O3 | O1 / O2 / O3 | O2 / O3 / O7 |
| Operation: | Handle | Handle | 2 handles | 2 handles |
| Stacking: | Top stack, with bottom side-guide fixing | Bottom stack, with top side-guide fixing | At the top and bottom adjustable blind. With top headrail and bottom side-guide fixing | At the top and bottom adjustable blind. With top and bottom side-guide fixing |

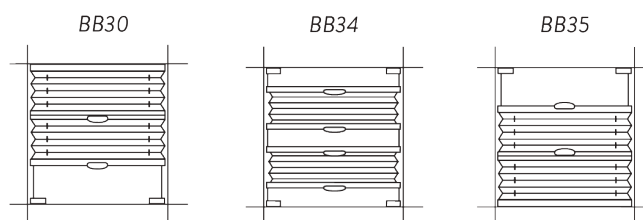

| | | | |
|-------------------|---|--|---|
| Standard fitting: | Top / Inside recess fix | Top / Inside recess fix | Top / Inside recess fix |
| Fitting options: | M1 / M2 / M3 / M4 | M1 / M2 / M3 / M4 / M5 / M6 | M1 / M2 / M3 / M4 |
| System options: | O1 / O2 / O3 | O2 / O3 / O7 | O2 / O3 |
| Operation: | 2 handles | 4 handles | 2 handles |
| Stacking: | With 2 different fabrics (day and night decoration), top stack. With bottom side-guide fixing | With 2 different fabrics (day and night decoration). With top and bottom side-guide fixing | With 2 different fabrics (day and night decoration), bottom stack. With top side-guide fixing |

- Pleated blinds with side-guides
- Up to 15° inclination
- Incl. tilt and turn windows
- Attention! Please note the minimum and maximum measurement restrictions in the tables on pages 6 / 7!

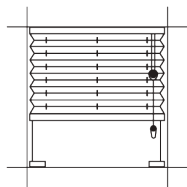
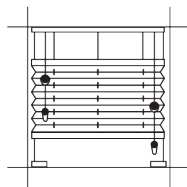
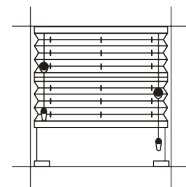
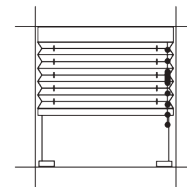
| | BO10 | BO20 | BO30 | BK10 |
|-------------------|---|--|---|---|
| |  |  |  |  |
| Standard fitting: | Top / Inside recess fix | Top / Inside recess fix | Top / Inside recess fix | Top / Inside recess fix |
| Fitting options: | M1/M2/M3/M4 | M1/M2/M3/M4 | M1/M2/M3/M4 | M1/M2/M3/M4 |
| System options: | O1/O3 | O1/O3 | O1/O3 | O1 |
| Operation: | Pull cord with cord lock | Pull cord with 2 cord locks | Pull cord with 2 cord locks | Chain with safety retainer. Gear in headrail (34 mm) |
| Stacking: | Top stack, with bottom side-guide fixing | At the top and bottom adjustable blind. With top headrail and bottom side-guide fixing | With 2 different fabrics (day and night decoration), top stack. With bottom side-guide fixing | Top stack, with bottom side-guide fixing |

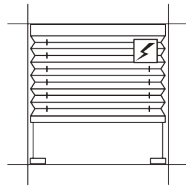
| | BE10 |
|-------------------|---|
| |  |
| Standard fitting: | Top / Inside recess fix |
| Fitting options: | M1/M2/M3/M4 |
| System options: | O1/O2 |
| Operation: | Electric. Motor (24 V DC) in headrail (34 mm) |
| Stacking: | Top stack, with bottom side-guide fixing |

- Pleated blinds with side-guides
- Up to 15° inclination
- Incl. tilt and turn windows
- Attention! Please note the minimum and maximum measurement restrictions in the tables on pages 6 / 7!

**D. VERTICAL
WINDOWS UP TO
15° INCLINATION /
SPECIAL SHAPES**

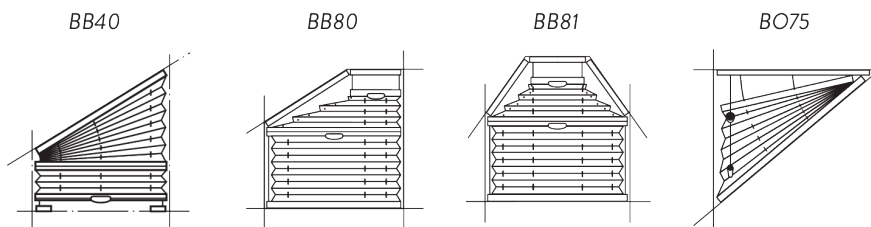

| | | | | |
|-------------------|--|--|---|---|
| Standard fitting: | Top / Inside recess fix | Top / Inside recess fix | Top / Inside recess fix | Top / Inside recess fix |
| Fitting options: | M1 / M2 / M3 | M1 / M2 / M3 | M1 / M2 / M3 | M1 / M2 / M3 |
| System options: | O1 | - | - | - |
| Operation: | Handle | 2 handles | 2 handles | Pull cord with cord lock |
| Stacking: | Top stack, raising to the smaller height | Bottom stack with side-guide and top headrail on the slope | Bottom stack with side-guide and top headrail on the slopes | Bottom stack with side-guide and top headrail |

- Pleated blinds with side-guides
- Up to 15° inclination
- Incl. tilt and turn windows
- Attention! Please note the minimum and maximum measurement restrictions in the tables on pages 6 / 7!

**E. VERTICAL
WINDOWS /
ROUND SPECIAL
SHAPES**

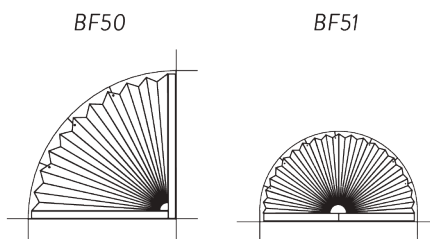

| | | |
|-------------------|---|---|
| Standard fitting: | Top / Inside recess fix | Top / Inside recess fix |
| Fitting options: | - | - |
| System options: | - | - |
| Operation: | Fixed | Fixed |
| Stacking: | Fabric with pressed eyelets for fastening with hook bolts | Fabric with pressed eyelets for fastening with hook bolts |

- Blind fixed, not movable
- Attention! Please note the minimum and maximum measurement restrictions in the tables on pages 6 / 7!

**F. ROOF AND PIVOT
WINDOWS UP TO
60°
INCLINATION /
RECTANGULAR
SHAPES**

DB10

DB20

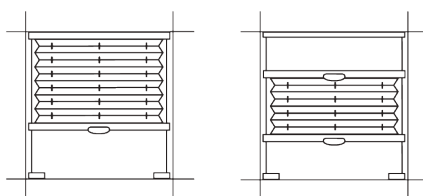

| | | |
|-------------------|--|--|
| Standard fitting: | Top / Inside recess fix | Top / Inside recess fix |
| Fitting options: | M1/M2/M3 | M1/M2/M3 |
| System options: | O1/O2/O3 | O1/O2/O3 |
| Operation: | Handle | 2 handles |
| Stacking: | Top stack, with bottom side-guide fixing | At the top and bottom adjustable blind. With top headrail and bottom side-guide fixing |

- Pleated blinds with side-guides
- Up to 60° inclination
- Attention! Please note the minimum and maximum measurement restrictions in the tables on pages 6 / 7!

**G. CEILING
WINDOWS AND
SKYLIGHTS,
INCLINATION
BETWEEN 45° AND
90° /
RECTANGULAR
SHAPES**

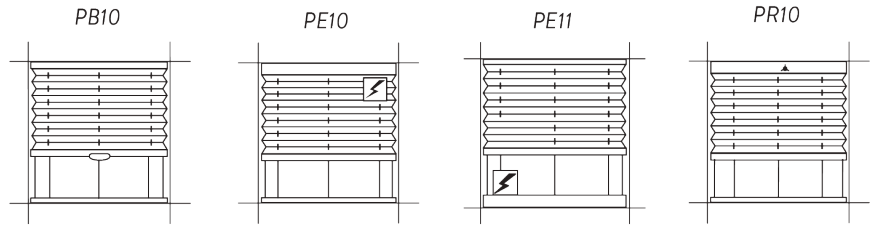

| | | | | |
|-------------------|-------------------------------|---|--|--------------------------------------|
| Standard fitting: | Top / Inside recess fix | Top / Inside recess fix | Top / Inside recess fix | Top / Inside recess fix |
| Fitting options: | M1/M2/M3 | M1/M2/M3 | M1/M2/M3 | M1/M2/M3 |
| System options: | O2/O3 | O2 | O2 | O2 |
| Operation: | Handle | Electric. Motor (24 V DC) in headrail (34 mm) | Electric. Motor (24 V DC) in bottom rail (34 mm) | Crank on headrail (34 mm) |
| Stacking: | Top stack with bottom rail | Top stack / gear with bottom rail | Top stack / bottom gear | top stack / gear with bottom rail |

PR11

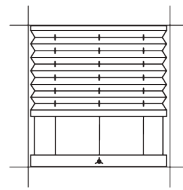

| | |
|-------------------|---------------------------------|
| Standard fitting: | Top / Inside recess fix |
| Fitting options: | M1/M2/M3 |
| System-Optionen: | O2 |
| Operation: | Crank on bottom rail (34 mm) |
| Stacking: | Top stack / bottom gear |

- With permanent steel wire tensioning
- Inclination between 45° and 90° (= horizontal)
- Attention! Please note the minimum and maximum measurement restrictions in the tables on pages 6 / 7!

**H. CEILING
WINDOWS AND
SKYLIGHTS,
INCLINATION
BETWEEN 45°
AND 90° /
SPECIAL SHAPES**

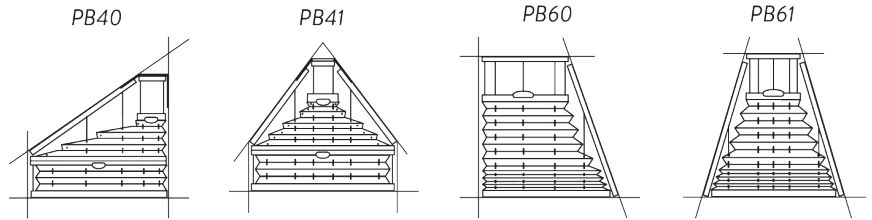

| | | | | |
|-------------------|---|--|--|--|
| Standard fitting: | Top / Inside recess fix | Top / Inside recess fix | Top / Inside recess fix | Top / Inside recess fix |
| Fitting options: | - | - | M1/M2/M3 | M1/M2/M3 |
| System options: | - | - | - | - |
| Operation: | 2 handles | 2 handles | Handle | Handle |
| Stacking: | Bottom stack with top headrail on the slope | Bottom stack with top headrail on the slopes | Bottom stack with top headrail on the slopes | Bottom stack with top headrail on the slopes |

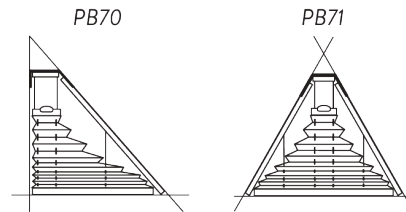

| | | |
|-------------------|---|--|
| Standard fitting: | Top / Inside recess fix | Top / Inside recess fix |
| Fitting options: | - | - |
| System options: | - | - |
| Operation: | Handle | Handle |
| Stacking: | Bottom stack with top headrail on the slope | Bottom stack with top headrail on the slopes |

- With permanent steel wire tensioning
- Inclination between 45° and 90° (= horizontal)
- Attention! Please note the minimum and maximum measurement restrictions in the tables on pages 6 / 7!

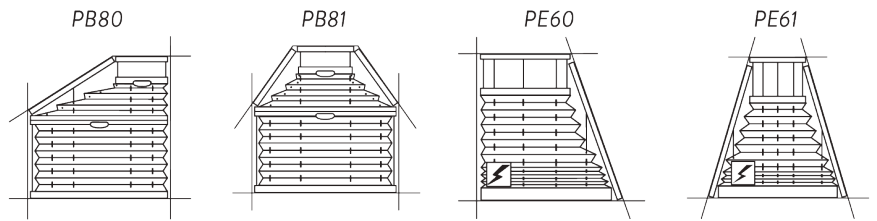

| | | | | |
|-------------------|--|---|--|--|
| Standard fitting: | Top / Inside recess fix | Top / Inside recess fix | Top / Inside recess fix | Top / Inside recess fix |
| Fitting options: | M1/M2/M3 | M1/M2/M3 | M1/M2/M3 | M1/M2/M3 |
| System options: | - | - | - | - |
| Operation: | 2 handles | 2 handles | Electric. Motor (24 V DC) in bottom rail (34 mm) | Electric. Motor (24 V DC) in bottom rail (34 mm) |
| Stacking: | Bottom stack with top headrail on the slope | Bottom stack with top headrail on the slopes | Bottom stack / gear with headrail on the slope | Bottom stack / gear with headrail on the slopes |

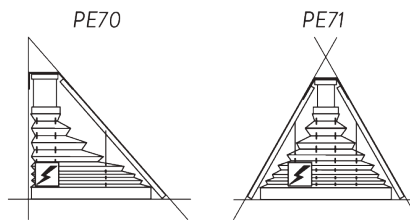

| | | |
|-------------------|--|--|
| Standard fitting: | Top / Inside recess fix | Top / Inside recess fix |
| Fitting options: | - | - |
| System options: | - | - |
| Operation: | Electric. Motor (24 V DC) in bottom rail (34 mm) | Electric. Motor (24 V DC) in bottom rail (34 mm) |
| Stacking: | Bottom stack / gear with headrail on the slope | Bottom stack / gear with headrail on the slopes |

- With permanent steel wire tensioning
- Inclination between 45° and 90° (= horizontal)
- Attention! Please note the minimum and maximum measurement restrictions in the tables on pages 6 / 7

I. STACK SIZES (MEASUREMENTS IN CM)

| Pleated blinds | | Blind type | | | |
|----------------|----|------------------------|------------------|------------------|------|
| System height | FC | BB10, BB15, AO10, BO10 | BB20, BB24, BO30 | BB30, BB35, BO20 | BB34 |
| 50 | 1 | 3,5 | 4,0 | 6,0 | 9,0 |
| | 2 | 4,0 | 4,5 | 6,5 | 9,5 |
| | 3 | 4,5 | 5,0 | 7,0 | 10,0 |
| 100 | 1 | 4,0 | 4,5 | 6,5 | 10,0 |
| | 2 | 5,0 | 5,5 | 7,5 | 10,5 |
| | 3 | 5,5 | 6,0 | 8,5 | 11,5 |
| 150 | 1 | 4,5 | 5,0 | 7,5 | 10,5 |
| | 2 | 5,5 | 6,0 | 9,0 | 12,0 |
| | 3 | 7,0 | 7,5 | 10,0 | 13,0 |
| 200 | 1 | 5,0 | 5,5 | 8,5 | 11,5 |
| | 2 | 6,5 | 7,0 | 10,0 | 13,0 |
| | 3 | 8,0 | 8,5 | 12,0 | 15,0 |
| 250 | 1 | 5,0 | 6,0 | 9,0 | 12,0 |
| | 2 | 7,0 | 7,5 | 11,5 | 14,5 |
| | 3 | 9,5 | 10,0 | 13,5 | 16,5 |

FC = Fabric class

| DUETTE® | | Blind type | | | | |
|---------------|-----|------------------------|------------------|------------------|------|------|
| System height | FC | BB10, BB15, AO10, BO10 | BB20, BB24, BO30 | BB30, BB35, BO20 | BB34 | |
| 50 | 2 | 4,0 | 5,5 | 8,0 | 11,0 | |
| | 3 | 4,5 | 6,0 | 9,0 | 12,0 | |
| | 4 | 5,5 | 7,0 | 10,5 | 13,5 | |
| | 5 | 6,0 | 7,5 | 12,0 | 15,0 | |
| | 100 | 2 | 5,0 | 6,5 | 10,0 | 13,0 |
| 100 | 3 | 6,0 | 7,5 | 11,5 | 14,5 | |
| | 4 | 7,5 | 9,0 | 14,5 | 17,5 | |
| | 5 | 9,0 | 10,5 | 18,0 | 21,0 | |
| | 150 | 2 | 6,0 | 7,5 | 11,5 | 14,5 |
| | 3 | 7,0 | 8,5 | 14,0 | 17,0 | |
| 150 | 4 | 9,5 | 11,0 | 18,5 | 21,5 | |
| | 5 | 12,0 | 13,5 | 23,5 | 26,5 | |
| | 200 | 2 | 6,5 | 8,0 | 13,0 | 16,0 |
| | 3 | 8,5 | 10,0 | 16,5 | 19,5 | |
| | 4 | 11,5 | 13,0 | 22,5 | 25,5 | |
| 200 | 5 | - | - | - | - | |
| | 250 | 2 | 7,5 | 9,0 | 14,5 | 17,5 |
| | 3 | 9,5 | 11,0 | 19,0 | 22,0 | |
| | 4 | 13,0 | 14,5 | 26,0 | 29,0 | |
| | 5 | - | - | - | - | |

| Pleated blinds | | Blind type | |
|----------------|----|------------|------------|
| System height | FC | AE10, AK10 | BE10, BK10 |
| 50 | 1 | 5,5 | 5,5 |
| | 2 | 6,0 | 6,0 |
| | 3 | 6,5 | 6,5 |
| 100 | 1 | 6,0 | 6,0 |
| | 2 | 7,0 | 7,0 |
| | 3 | 7,5 | 7,5 |
| 150 | 1 | 6,5 | 6,5 |
| | 2 | 7,5 | 7,5 |
| | 3 | 9,0 | 9,0 |
| 200 | 1 | 7,0 | 7,0 |
| | 2 | 8,5 | 8,5 |
| | 3 | 10,0 | 10,0 |
| 250 | 1 | 7,0 | 7,0 |
| | 2 | 9,0 | 9,0 |
| | 3 | 11,5 | 11,5 |

FC = Fabric class

| DUETTE® | | Blind type | |
|---------------|----|------------|------------|
| System height | FC | AE10, AK10 | BE10, BK10 |
| 50 | 2 | 6,0 | 6,0 |
| | 3 | 6,5 | 6,5 |
| | 4 | 7,0 | 7,0 |
| | 5 | 8,0 | 8,0 |
| | | | |
| 100 | 2 | 7,0 | 7,0 |
| | 3 | 8,0 | 8,0 |
| | 4 | 9,0 | 9,5 |
| | 5 | 11,0 | 11,0 |
| | | | |
| 150 | 2 | 7,5 | 7,5 |
| | 3 | 9,0 | 9,0 |
| | 4 | 11,0 | 11,5 |
| | 5 | 13,5 | 14,0 |
| | | | |
| 200 | 2 | 8,5 | 8,5 |
| | 3 | 10,0 | 10,5 |
| | 4 | 13,0 | 13,0 |
| | 5 | - | - |
| | | | |
| 250 | 2 | 9,0 | 9,5 |
| | 3 | 11,5 | 11,5 |
| | 4 | 15,0 | 15,0 |
| | 5 | - | - |
| | | | |

| Pleated blinds | | Blind type | |
|----------------|----|------------------------|------------|
| System height | FC | AO40, BB40, BB80, BB81 | AO70, BO75 |
| 50 | 1 | 5,0 | 3,5 |
| | 2 | 5,5 | 4,0 |
| | 3 | 6,0 | 4,5 |
| 100 | 1 | 5,5 | 4,0 |
| | 2 | 6,0 | 4,5 |
| | 3 | 7,0 | 5,5 |
| 150 | 1 | 6,0 | 4,5 |
| | 2 | 7,0 | 5,5 |
| | 3 | 8,5 | 7,0 |
| 200 | 1 | 6,5 | 5,0 |
| | 2 | 8,0 | 6,5 |
| | 3 | 9,5 | 8,0 |
| 250 | 1 | 7,0 | 5,5 |
| | 2 | 8,5 | 7,0 |
| | 3 | 11,0 | 9,5 |

FC = Fabric class

| DUETTE® | | Blind type | |
|---------------|----|------------------------|------------|
| System height | FC | AO40, BB40, BB80, BB81 | AO70, BO75 |
| 50 | 2 | 5,5 | 4,0 |
| | 3 | 6,0 | 4,5 |
| | 4 | 6,5 | 5,0 |
| | 5 | 7,5 | 6,0 |
| | | | |
| 100 | 2 | 6,5 | 5,0 |
| | 3 | 7,0 | 5,5 |
| | 4 | 8,5 | 7,0 |
| | 5 | 10,5 | 9,0 |
| | | | |
| 150 | 2 | 7,0 | 5,5 |
| | 3 | 8,5 | 7,0 |
| | 4 | 11,0 | 9,0 |
| | 5 | 13,0 | 11,5 |
| | | | |
| 200 | 2 | 8,0 | 6,5 |
| | 3 | 10,0 | 8,0 |
| | 4 | 12,5 | 11,0 |
| | 5 | - | - |
| | | | |
| 250 | 2 | 9,0 | 7,0 |
| | 3 | 11,0 | 9,5 |
| | 4 | 14,5 | 13,0 |
| | 5 | - | - |
| | | | |

| Pleated blinds | | Blind type | |
|----------------|----|------------|------|
| System height | FC | DB10 | DB20 |
| 50 | 1 | 4,0 | 4,5 |
| | 2 | 4,5 | 5,0 |
| | 3 | 5,0 | 5,5 |
| 100 | 1 | 4,5 | 5,0 |
| | 2 | 5,0 | 5,5 |
| | 3 | 6,0 | 6,5 |
| 150 | 1 | 5,0 | 5,5 |
| | 2 | 6,0 | 6,5 |
| | 3 | 7,5 | 8,0 |
| 200 | 1 | 5,5 | 6,0 |
| | 2 | 7,0 | 7,5 |
| | 3 | 8,5 | 9,0 |

FC = Fabric class

| DUETTE® | | Blind type | |
|---------------|----|------------|------|
| System height | FC | DB10 | DB20 |
| 50 | 2 | 4,5 | 5,0 |
| | 3 | 5,0 | 5,5 |
| | 4 | 5,5 | 6,0 |
| | 5 | 6,5 | 7,0 |
| | | | |
| 100 | 2 | 5,5 | 6,0 |
| | 3 | 6,0 | 6,5 |
| | 4 | 7,5 | 8,0 |
| | 5 | 9,5 | 10,0 |
| | | | |
| 150 | 2 | 6,0 | 6,5 |
| | 3 | 7,5 | 8,0 |
| | 4 | 9,5 | 10,0 |
| | 5 | 12,0 | 12,5 |
| | | | |
| 200 | 2 | 7,0 | 7,5 |
| | 3 | 8,5 | 9,0 |
| | 4 | 11,5 | 12,0 |
| | 5 | - | - |
| | | | |

| Pleated blinds | | Blind type | |
|----------------|----|------------------|------------|
| System height | FC | PB10, PE11, PR11 | PE10, PR10 |
| 50 | 1 | 4,0 | 6,0 |
| | 2 | 4,5 | 6,5 |
| | 3 | 5,0 | 7,0 |
| 100 | 1 | 4,5 | 6,5 |
| | 2 | 5,0 | 7,0 |
| | 3 | 6,0 | 8,0 |
| 150 | 1 | 5,0 | 7,0 |
| | 2 | 6,0 | 8,0 |
| | 3 | 7,5 | 9,5 |
| 200 | 1 | 5,5 | 7,5 |
| | 2 | 7,0 | 9,0 |
| | 3 | 9,0 | 10,5 |
| 250 | 1 | 6,0 | 8,0 |
| | 2 | 8,0 | 10,0 |
| | 3 | 10,0 | 12,0 |
| 300 | 1 | 6,0 | 8,0 |
| | 2 | 8,5 | 10,5 |
| | 3 | 11,0 | 13,0 |
| 350 | 1 | 6,5 | 8,5 |
| | 2 | 9,0 | 11,0 |
| | 3 | 12,0 | 14,0 |

FC = Fabric class

| DUETTE® | | Blind type | |
|---------------|----|------------------|------------|
| System height | FC | PB10, PE11, PR11 | PE10, PR10 |
| 50 | 2 | 4,5 | 6,5 |
| | 3 | 5,0 | 7,0 |
| | 4 | 5,5 | 7,5 |
| | 5 | 6,5 | 8,5 |
| | 2 | 5,5 | 7,5 |
| 100 | 3 | 6,0 | 8,0 |
| | 4 | 7,5 | 9,5 |
| | 5 | 9,5 | 11,5 |
| 150 | 2 | 6,0 | 8,0 |
| | 3 | 7,5 | 9,5 |
| | 4 | 10,0 | 11,5 |
| | 5 | 12,0 | 14,0 |
| | 2 | 7,0 | 9,0 |
| 200 | 3 | 8,5 | 10,5 |
| | 4 | 11,5 | 13,5 |
| | 5 | - | - |
| | 2 | 8,0 | 10,0 |
| | 3 | 10,0 | 12,0 |
| 250 | 4 | 13,5 | 15,5 |
| | 5 | - | - |
| | 2 | 8,5 | 10,5 |
| | 3 | 11,0 | 13,0 |
| | 4 | 15,0 | 17,0 |
| 300 | 5 | - | - |
| | 2 | 9,0 | 11,0 |
| | 3 | 12,0 | 14,0 |
| | 4 | 17,0 | 19,0 |
| | 5 | - | - |

| Pleated blinds | | Blind type | | |
|----------------|----|------------------------|------------------------|------------------------|
| System height | FC | PB40, PB41, PB80, PB81 | PB60, PB61, PB70, PB71 | PE60, PE61, PE70, PE71 |
| 50 | 1 | 6,0 | 4,0 | 6,0 |
| | 2 | 6,5 | 4,5 | 6,5 |
| | 3 | 7,0 | 5,0 | 7,0 |
| 100 | 1 | 6,5 | 4,5 | 6,5 |
| | 2 | 7,5 | 5,5 | 7,5 |
| | 3 | 8,0 | 6,0 | 8,0 |
| 150 | 1 | 7,0 | 5,0 | 7,0 |
| | 2 | 8,0 | 6,0 | 8,0 |
| | 3 | 9,5 | 7,5 | 9,5 |
| 200 | 1 | 7,5 | 5,5 | 7,5 |
| | 2 | 9,0 | 7,0 | 9,0 |
| | 3 | 10,5 | 8,5 | 10,5 |
| 250 | 1 | 8,0 | 6,0 | 8,0 |
| | 2 | 9,5 | 7,5 | 9,5 |
| | 3 | 12,0 | 10,0 | 12,0 |







FC = Fabric class

| DUETTE® | | Blind type | | |
|---------------|----|------------------------|------------------------|------------------------|
| System height | FC | PB40, PB41, PB80, PB81 | PB60, PB61, PB70, PB71 | PE60, PE61, PE70, PE71 |
| 50 | 2 | 6,5 | 4,5 | 6,5 |
| | 3 | 7,0 | 5,0 | 7,0 |
| | 4 | 7,5 | 5,5 | 7,5 |
| | 5 | 8,5 | 6,5 | 8,5 |
| | 2 | 7,0 | 5,0 | 7,0 |
| 100 | 3 | 8,0 | 6,0 | 8,0 |
| | 4 | 9,5 | 7,5 | 9,5 |
| | 5 | 11,5 | 9,5 | 11,5 |
| | 2 | 8,0 | 6,0 | 8,0 |
| | 3 | 9,5 | 7,5 | 9,5 |
| 150 | 4 | 11,5 | 9,5 | 11,5 |
| | 5 | 14,0 | 12,0 | 14,0 |
| | 2 | 9,0 | 7,0 | 9,0 |
| | 3 | 10,5 | 8,5 | 10,5 |
| | 4 | 13,5 | 11,5 | 13,5 |
| 200 | 5 | - | - | - |
| | 2 | 9,5 | 7,5 | 9,5 |
| | 3 | 12,0 | 10,0 | 12,0 |
| | 4 | - | - | - |
| | 5 | - | - | - |

ELECTRIC OPTIONS

A. OPERATING METHODS

| | | | | | | | | | | |
|-----------------------------------|---|---|---|---|--|--|--|---|---|---|
| Switch with power supply | • | | | | | | | | | |
| Control unit without power supply | | • | | | | | | | | |
| Power supply | | | • | • | | | | | | |
| Radio control 1-channel | | | | | | | | • | | |
| Radio control 4-channel | | | | | | | | | • | |
| Radio receiver | | | | | | | | | | • |

| Blind type | Option | Control by wire | Radio control | Single control | Group control |  |  |  |  |  |  |  |
|----------------|--------|-----------------|---------------|----------------|---------------|---|---|--|---|---|---|---|
| | | | | | | UP 308001130 | UP 308001093 | * 305000514 | 308001137 | 308001089 | 308001090 | * 308001132 |
| AE BE PE | E11 | • | | • | | • | | | | | | |
| | E12 | • | | | • | | • (1) | | • (2) | | | |
| | E13 | | | • | • | | | • | • | | | • |
| | E14 | | • | • | • | | | | • (2) | | • | • (3) |

- * Installation of the radio receiver 308001132 in the top rail increases the minimum width of PE models by 10 cm! Additional installation of the power supply unit 305000514 in the top rail increases this dimension by a further 25 cm!

- (1) a maximum of 3 motors
- (2) a maximum of 5 motors
- (3) per motor

- In order to ensure that the systems function properly, only electrical components recommended by Silent Gliss may be used!

- The use of components not recommended by Silent Gliss will invalidate the warranty!

PARTS

A. STANDARD PARTS



SG 8325

Handle

B. OPTIONAL PARTS



SG 8501

Logoplate



SG 10742

Child safety cord cleat

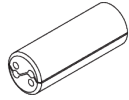

SG 10745

Child safety break away cord connector

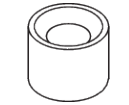

SG 10749

Eyelet

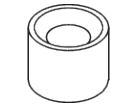

SG 10898

Child safety cord bush

The Architects of Silence

Silent Gliss is the leading global supplier of premium interior window treatments. Since 1952 we have been tirelessly committed to the development of the world's smoothest, quietest systems using state of the art technology.

Driven by customer needs, Silent Gliss offers functional and durable products. Expert technical advice coupled with installation and support services complete the offer. Silent Gliss stands for innovative, sustainable, tailor made solutions, exceptional design and first-class quality.

Silent Gliss Ltd.

Pyramid Business Park
Poorhole Lane, Broadstairs
Kent CT10 2PT
United Kingdom
T +44 1843 863571
F +44 1843 864503
info@silentgliss.co.uk

Silent Gliss Global Ltd.

Pyramid Business Park
Poorhole Lane, Broadstairs
Kent CT10 2PT
United Kingdom
T +44 1843 874250
F +44 1843 864503
info@silentglissglobal.com

Silent Gliss Blinds Trading LLC

Office 1906
The H Hotel Complex
Trade Center First
Dubai
United Arab Emirates
T +971 4 7050318
info@silentgliss.ae

silentgliss.co.uk
silentglissglobal.com
silentgliss.ae