

# SG 2345

---

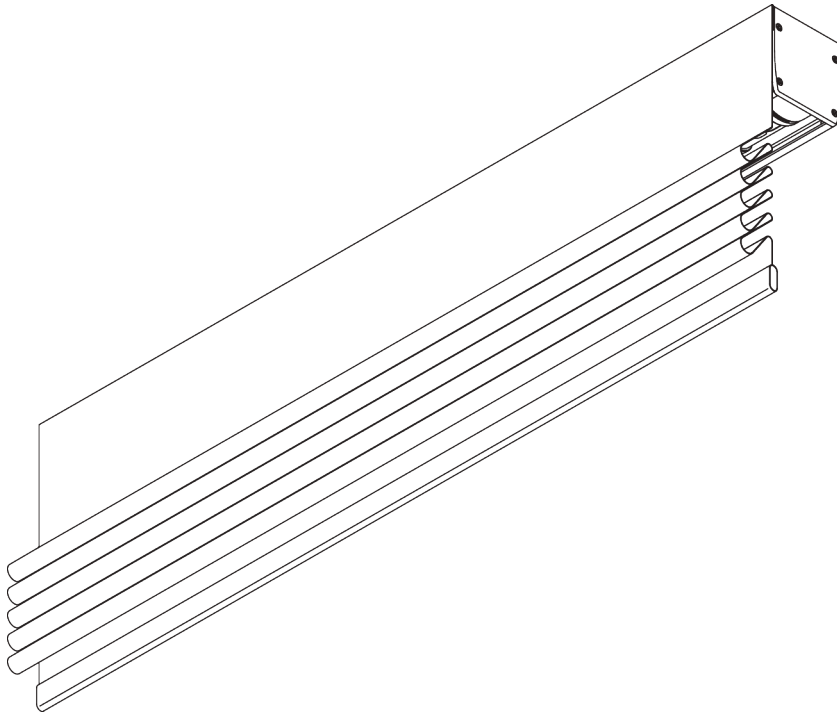
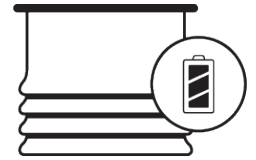

## PRODUCT INFORMATION

- **Operation:** motorised (battery operated)
- **Range:** S - M
- **Fitting:** ceiling, wall
- **Colours:** white RAL 9016
- **Fabrics:** refer to Silent Gliss fabric collection

### **Features:**

- Various control options
- Easy exchange of batteries
- Enclosed headrail

# SYSTEM SPECIFICATIONS

## A. SYSTEM DIMENSIONS



6 m



60 cm

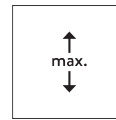

6 m



2.5 kg

## B. PROFILE

Profile information

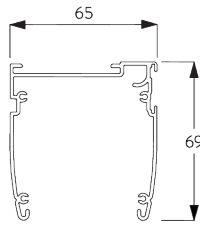

SG 2351  
Profile

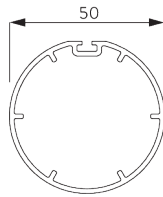

SG 2352  
Profile ø 50 mm

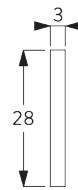

SG 2006  
Bottom bar 28x3 mm



SG 2135  
Rod steel ø 3 mm

## C. HOW TO MEASURE

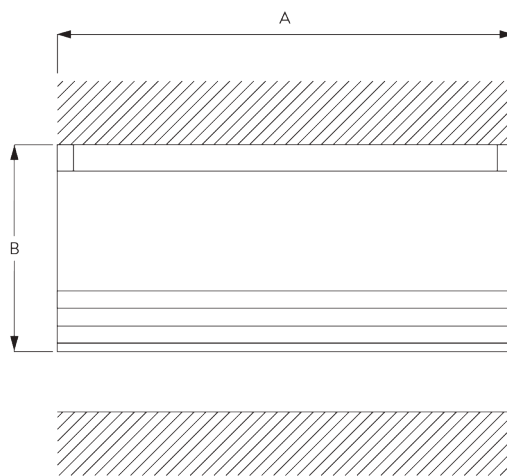

A: System width  
B: System height

## D. SPECIFICATION TEXT

**Silent Gliss SG 2345 Battery Operated Roman Blind System.** Ready-assembled comprising aluminium headbox SG 2351 made to measure powder coated in white finish with bonded hook and loop insert, winding tube SG 2352, lift cord SG 2216 and lift cord release mechanism SG 2353 / SG 2354. Ceiling/face fix using universal bracket SG 2363 / wall fix with Silent Gliss Smart Fix bracket range in conjunction with SG 2521 bracket. Integral motor SG 11076 and battery pack SG 11077 with 8 no. lithium batteries SG 11099. Supplied as standard with radio wall transmitter SG 10949. If supplied with made up blind from Silent Gliss fabric collection includes child safe breakaway components SG 31624 bottom bar set, SG 3069 rod cover (hard / semi hard fold makeup), SG 3165 / 3166 ring (soft fold make-up). Compliant to Child Safety legislation EN 13120

# FITTING

## A. FITTING INFORMATION

For detailed fitting information, visit the *Silent Gliss* website.

### Fixing points

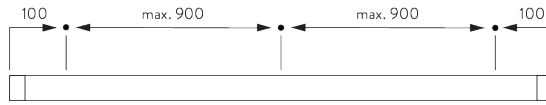

## B. CEILING FITTING

### Clamp SG 3003

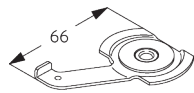
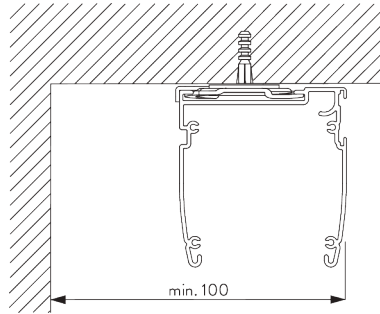

**SG 3003**  
Clamp

### Bracket SG 2521

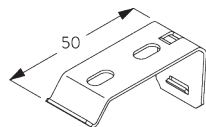
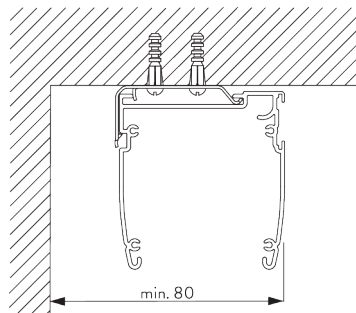

**SG 2521**  
Bracket

## C. WALL FITTING

### Bracket SG 2363

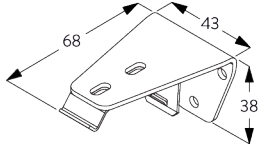
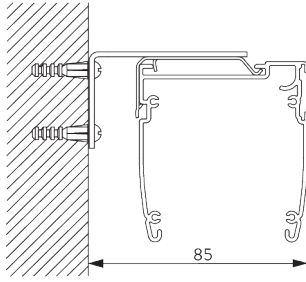

#### SG 2363

Bracket 68 mm

### Smart Fix

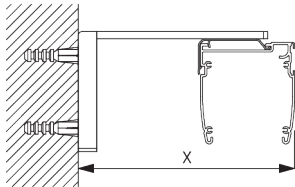

**Smart Fix SG 11200 - SG 11204 and bracket SG 2521:**  
Screw SG 10395 (M4x6) needed.

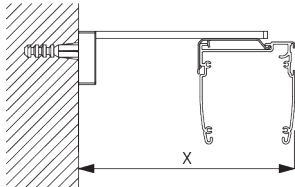

**Square Smart Fix SG 11210 - SG 11214 and bracket SG 2521:**  
Screw SG 10395 (M4x6) needed.

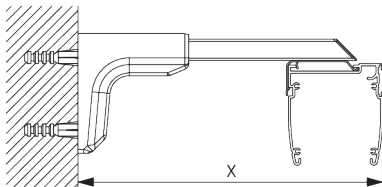

**Universal Smart Fix SG 11154 - SG 11156 and bracket SG 2521:**  
Screw SG 10492 (M4x8) needed.

Smart Fix	X mm
SG 11200 / SG 11210	80-84
SG 11201 / SG 11211	100-104
SG 11202 / SG 11212	120-124
SG 11203 / SG 11213	140-144
SG 11204 / SG 11214	170-174
SG 11154	134-162
SG 11155	164-192
SG 11156	214-242

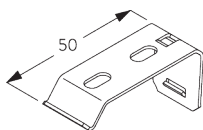

**SG 2521**  
Bracket



**SG 10395**  
Pan head screw M4x6



**SG 10492**  
Pan head screw M4x8

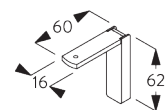

**SG 11200**  
Smart Fix 60 mm

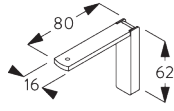

**SG 11201**  
Smart Fix 80 mm

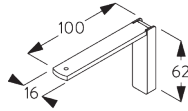

**SG 11202**  
Smart Fix 100 mm

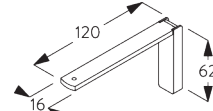

**SG 11203**  
Smart Fix 120 mm

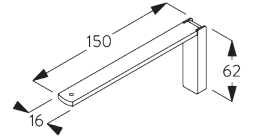

**SG 11204**  
Smart Fix 150 mm

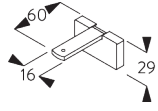

**SG 11210**  
Square Smart Fix 60 mm

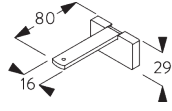

**SG 11211**  
Square Smart Fix 80 mm

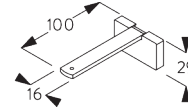

**SG 11212**  
Square Smart Fix 100 mm

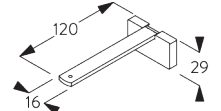

**SG 11213**  
Square Smart Fix 120 mm

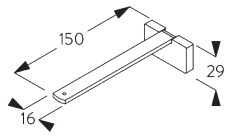

**SG 11214**  
Square Smart Fix 150 mm

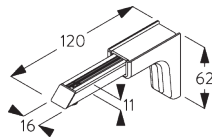

**SG 11154**  
Universal Smart Fix 120 mm

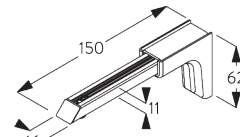

**SG 11155**  
Universal Smart Fix 150 mm

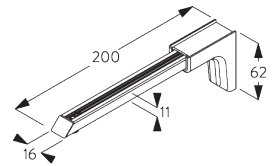

**SG 11156**  
Universal Smart Fix 200 mm

# SYSTEM OPTIONS

## A. FABRIC MAKE-UP

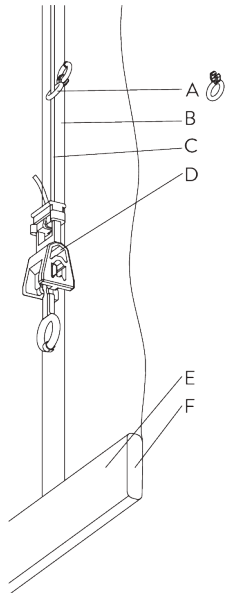

### Type A - Softfold

- A: Child safety tape set SG 3166
- B: Set includes tape and child safety eyelet
- C: Tape SG 2163
- D: Child safety hook set SG 3164
- E: Hollow hem
- F: Bottom bar SG 2005

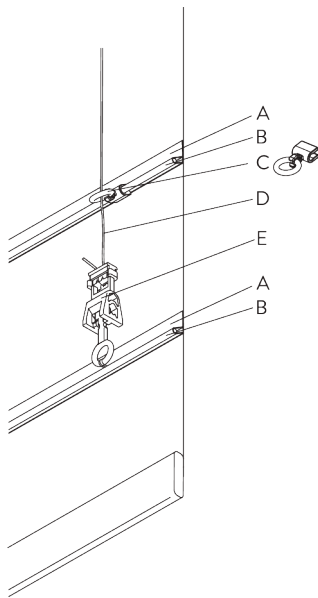

**Type B - Hardfold**

- A: Tape SG 2136
- B: Rod SG 2135
- C: Child safety eyelet hard fold SG 3069
- D: Tape SG 2163
- E: Child safety hook set SG 3164

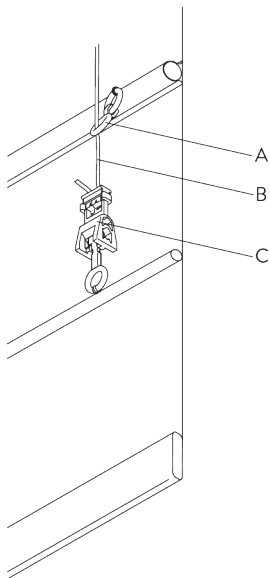

**Type C - Hardfold**

- A: Child safety eyelet set SG 3165
- B: Tape SG 2163
- C: Child safety hook set SG 3164

**B. BATTERY EXCHANGE**

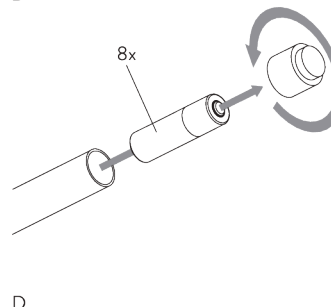
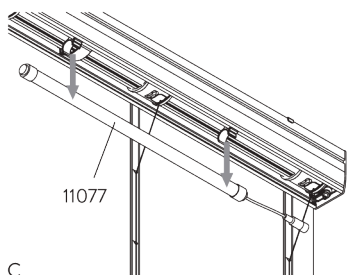
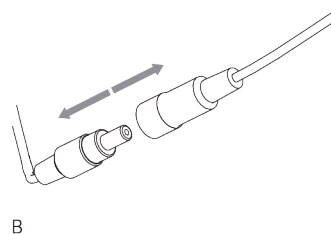
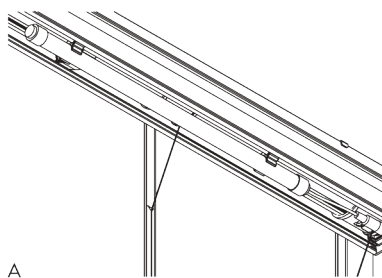

# MOTOR & CONTROLS

## A. MOTOR FEATURES

Motor	SG 11076
<b>Motor Features</b>	
Soft start / stop	●
Built-in receiver	●
Electronic end-stop	●
Electronic revolution counter (unlimited revolution)	●
IP class	IP 44
<b>Control Features</b>	
SG Control A	●

## B. MOTOR SPECIFICATIONS

Motor	Min. system width	Voltage	Current	Speed	Frequency receiver
SG 11076	60 cm	12 V DC	0.55 A	30 rpm	433 MHz

## C. OPERATION METHODS

See catalogue "controls" for details.



### SG Control A





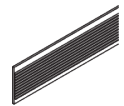
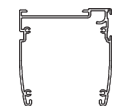
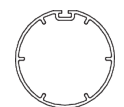
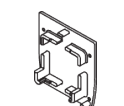
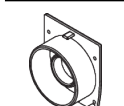
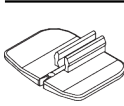

Various radio hand-held and wall transmitters available.

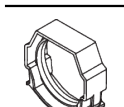
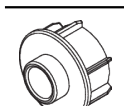
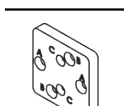
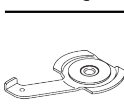
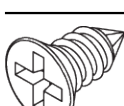
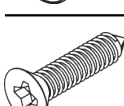

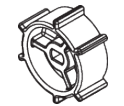
# PARTS

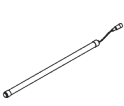
## A. STANDARD PARTS

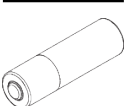
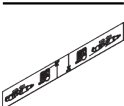
	<b>SG 2216</b> Cord ø 0.85 mm
	<b>SG 2221</b> Velcro tape
	<b>SG 2351</b> Profile
	<b>SG 2352</b> Profile ø 50 mm
	<b>SG 2353</b> End cover
	<b>SG 2354</b> End cover
	<b>SG 2357</b> Pin
	<b>SG 2358</b> Shell
	<b>SG 2359</b> Support
	<b>SG 2361</b> Tube adapter
	<b>SG 2368</b> Motor plate
	<b>SG 3003</b> Clamp
	<b>SG 10139</b> Countersunk screw 2.9x6.5
	<b>SG 10467</b> Countersunk head screw 2.9x13

	<b>SG 10949</b> Radio wall transmitter 1 channel
	<b>SG 11071</b> Motor drive
	<b>SG 11074</b> Tube adapter
	<b>SG 11076</b> Motor 12V DC, 1.2/30
	<b>SG 11077</b> Battery box
	<b>SG 11085</b> Battery box holder
	<b>SG 11099</b> AA Energizer Ultimate lithium batteries
	<b>SG 11103</b> Warning sticker

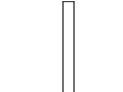
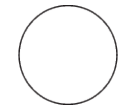
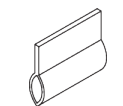
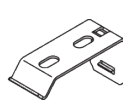
## B. OPTIONAL PARTS

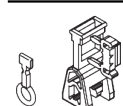
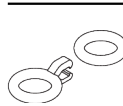
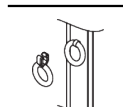
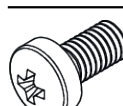
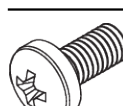
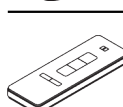
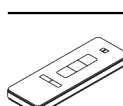
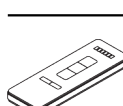
	<b>SG 2006</b> Bottom bar 28x3 mm
	<b>SG 2135</b> Rod steel ø 3 mm
	<b>SG 2136</b> Rod tape
	<b>SG 2521</b> Bracket
	<b>SG 2539</b> Tape
	<b>SG 3069</b> Child safety eyelet
	<b>SG 3164</b> Child safety hook set
	<b>SG 3165</b> Child safety eyelet set
	<b>SG 3166</b> Child safety tape set
	<b>SG 10395</b> Pan head screw M4x6
	<b>SG 10492</b> Pan head screw M4x8
	<b>SG 10946</b> Radio hand held 1 channel
	<b>SG 10947</b> Radio hand held 2+1 channel
	<b>SG 10948</b> Radio hand held 6+1 channel





**SG 10950**  
Radio wall transmitter 2 channel

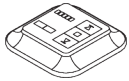

**SG 10951**  
Radio wall transmitter 5+1 channel

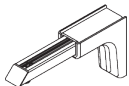

**SG 11154**  
Universal Smart Fix 120 mm

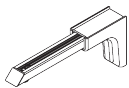

**SG 11155**  
Universal Smart Fix 150 mm

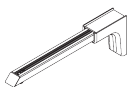

**SG 11156**  
Universal Smart Fix 200 mm

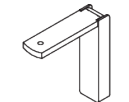

**SG 11200**  
Smart Fix 60 mm

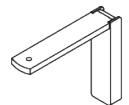

**SG 11201**  
Smart Fix 80 mm

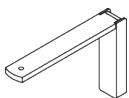

**SG 11202**  
Smart Fix 100 mm

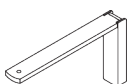

**SG 11203**  
Smart Fix 120 mm



**SG 11204**  
Smart Fix 150 mm

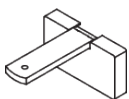

**SG 11210**  
Square Smart Fix 60 mm

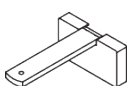

**SG 11211**  
Square Smart Fix 80 mm

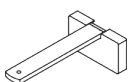

**SG 11212**  
Square Smart Fix 100 mm

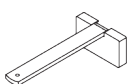

**SG 11213**  
Square Smart Fix 120 mm

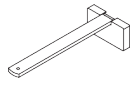

**SG 11214**  
Square Smart Fix 150 mm



**SG 11429**  
Radio timer unit 1 channel





