

SG 6650

SAFETY DEVICE

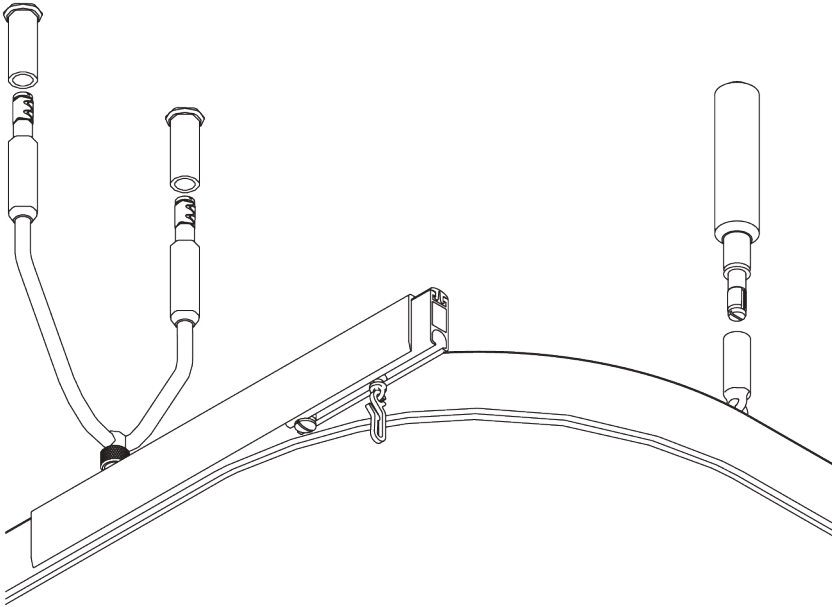
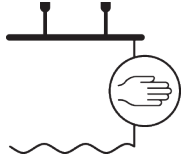

PRODUCT INFORMATION

- **Operation:** hand
- **Range:** S-L
- **Fitting:** suspended, ceiling, wall
- **Colours:** Anodised aluminum, special colours possible
- **Fabrics:** refer to Silent Gliss fabric collection

Features:

- Quick release safety device; for high risk areas to reduce opportunity for self harm
- Progressive disconnection of friction-based joints, wall supports and brackets at maximum static load of 40 kg
- Simple re-connection of hangers and brackets after separation
- For use with SG 6100

SYSTEM SPECIFICATIONS

A. PROFILE

Profile and bending information

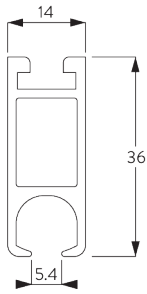

SG 6101

Profile

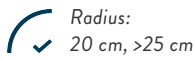

B. HOW TO MEASURE

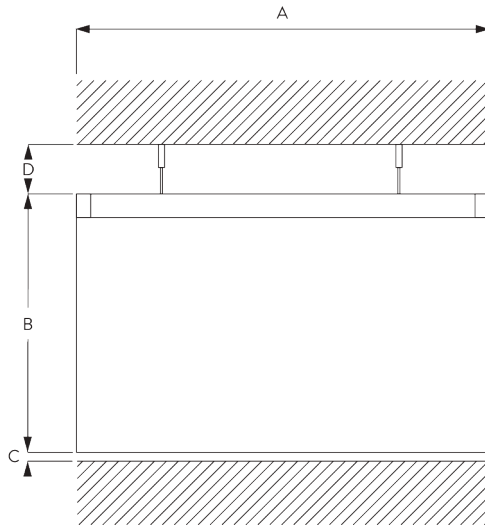

A: System width

B: System height

C: Distance between floor and fabric

D: Distance between ceiling and system

C. SPECIFICATION TEXT

Silent Gliss SG 6650 Safety Device System. The SG 6650 safety device system is designed for specific use with the SG 6100 cubicle system with the SG 6101 profile option only with nylon glider hook SG 6147 at 10/m. Key parts to add to SG 6100 system: End cover SG 6611 / Wall support set SG 6655 / SG Wall support combination SG 6668 / V-hanger with safety device SG 6658 / Vertical hanger with safety device SG 6651/ Acrylic plate SG 0785 / Wall bracket combination SG 6663 / Screw cover SG6672 / Connecting bridge SG 6666 / Washer SG 6671 . To be installed by Silent Gliss approved distributors only.

FITTING

A. FITTING INFORMATION

For detailed fitting information, visit the Silent Gliss website.

Fixing points

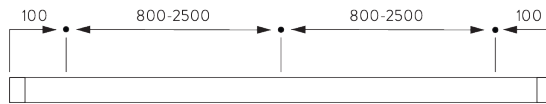

Dust Cover

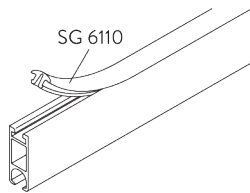

Site preparation for suspended ceiling applications

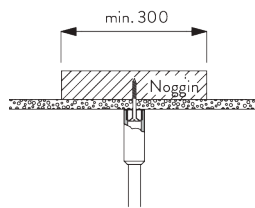

SG 6651

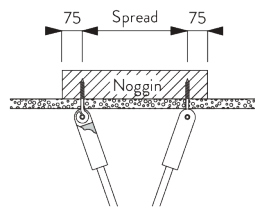

SG 6658

The SG 6650 system is intended to reduce the risk of self-harm in cubicle situations:

- **It must be fitted in accordance with the specific SG 6650 fitting instructions and only by approved Silent Gliss installers.**
- **Failure to do so will reduce its effectiveness.**
- Fixings should support ends of profile plus changes in direction.
- Maximum span between supports is 2.5 m. Position of supports can affect the performance of the system.
- At each hanger position a noggin in approved material is required above the suspended ceiling; to rest on top of ceiling (but independently supported), with a minimum length of 300 mm at right angles to the track in which the hanger occurs to give fixing tolerance.
- All completed systems must be risk assessed by a qualified installer.

B. CEILING FITTING

Hanger SG 6651

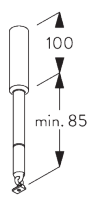
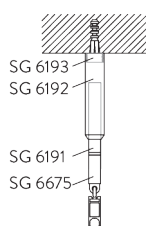

SG 6651

Hanger

V-hanger SG 6658

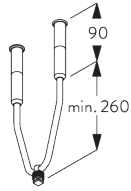
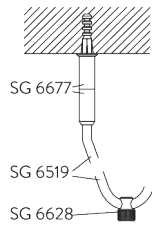

SG 6658

V-Hanger

C. WALL FITTING

Support SG 6655

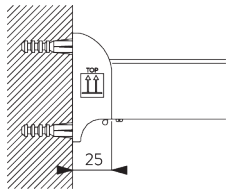

For head on fixing of profile

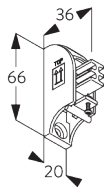

SG 6655

Wall support

Support SG 6668

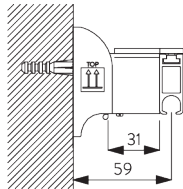

For parallel fixing of profile to the wall

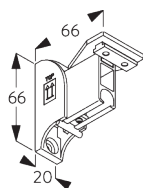

SG 6668

Wall bracket

**D. PROFILE
JUNCTION**

Connecting bridge
SG 6666

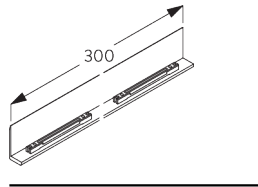
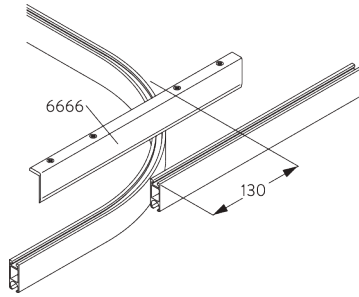

SG 6666
Connecting bridge

SYSTEM LAYOUT

**A. LAYOUT
OVERVIEW**

Typical track layout

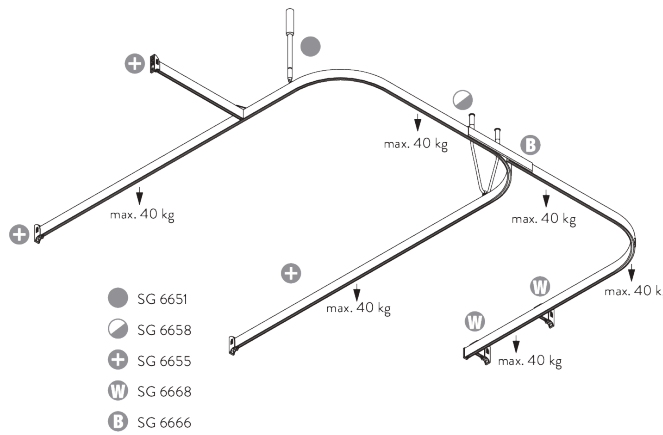

Straight Shower Rail

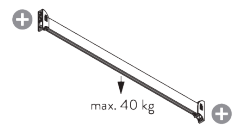

Bent Shower Rail/ /Door Screen

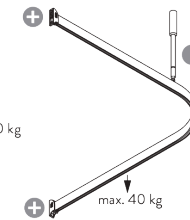

Room Dividers, Showers and Door Screens

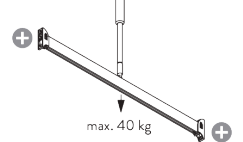

- As universal room divider system with various accessories, there are almost no limits to size and layouts.
- The recommended height from finished floor level to the underside of track is 2100 mm
- Typical method of obtaining stability is by attaching the system to the corridor wall or window.

B. LAYOUT OPTIONS

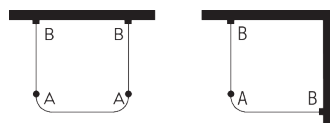

A: Hanger rod
B: Wall support

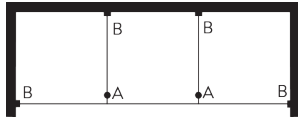

A: Hanger rod
B: Wall support

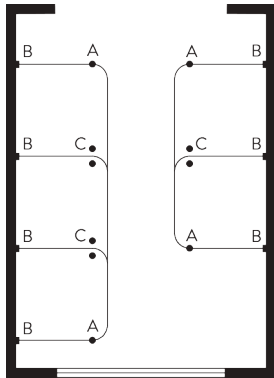

A: Hanger rod
B: Wall support
C: V-hanger

C. SAFETY KEY COMPONENTS

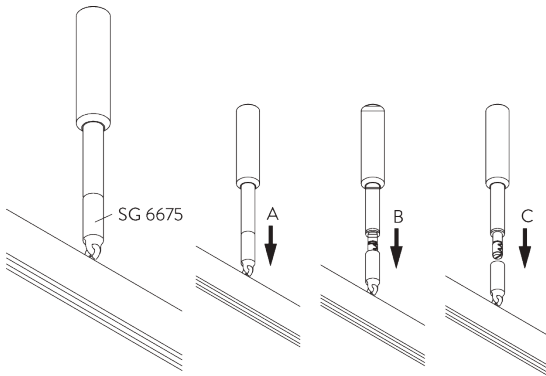

- SG 6675 safety device for single hanger.
- Pictured in the process of separating (A, B) and separated (C).

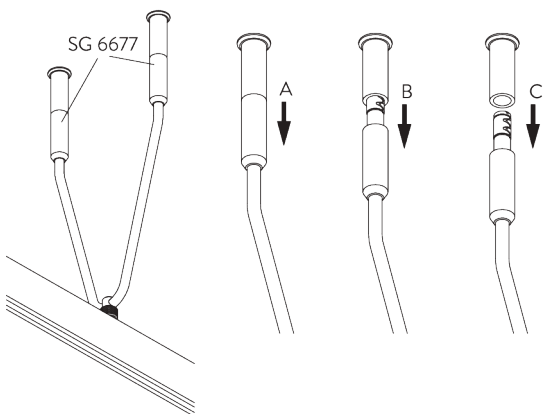

- SG 6677 safety device for V-hanger.
- V-hanger safety device assembly pictured here in the process of separating (A, B) and separated (C).

D. SEPARATION
LOADS

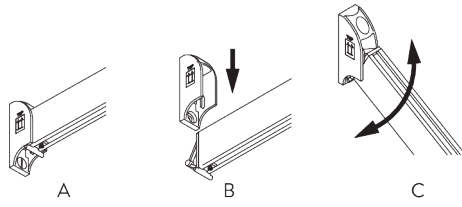

- Safety wall support SG 6655 (for right angled fixing of profile).
- Profile separates from wall support at given weight (A,B).
- The tilting function (C,D) ensures that profile will release when profile pulled at an angle.

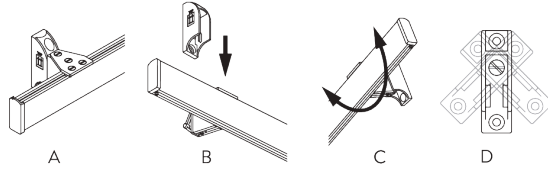

- Safety wall support SG 6668 (for parallel fixing of the profile to the wall).
- Profile separates from wall support at given weight (A,B).
- The profile will pivot in the bracket (C, D).

PARTS

A. STANDARD PARTS



SG 6101

Profile



SG 6110

Dust cover

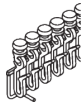

SG 6147

Glider with hook on strip

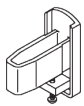

SG 6611

End cover



SG 6651

Hanger

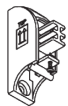

SG 6655

Wall support

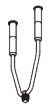

SG 6658

V-Hanger



SG 6666

Connecting bridge



SG 6668

Wall bracket



SG 6671

Washer



SG 6672

Cover



SG 6679

Acrylic disc

B. OPTIONAL PARTS

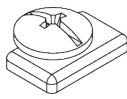

SG 11295

End stop