

SG 7610

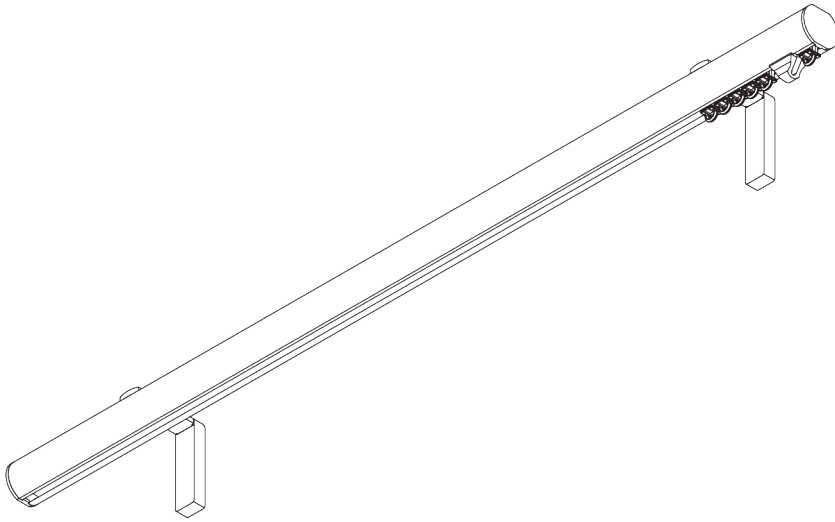
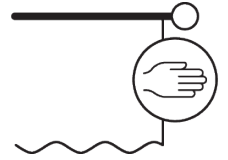

PRODUCT INFORMATION

- **Operation:** hand
- **Range:** S - M
- **Fitting:** ceiling, wall
- **Colours:** white RAL 9016, various colours / finishes
- **Fabrics:** refer to Silent Gliss fabric collection

Features:

- 2-component (2C) glider technology
- Wave (2C)
- Matching endcaps and brackets / bracket covers
- Range of decorative finials
- Bendable

SYSTEM SPECIFICATIONS

A. PROFILE

Profile and bending information

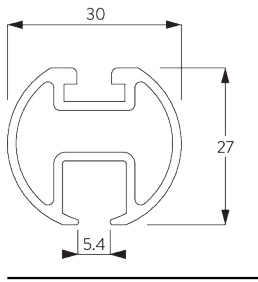

SG 6103p

Profile



B. HOW TO MEASURE

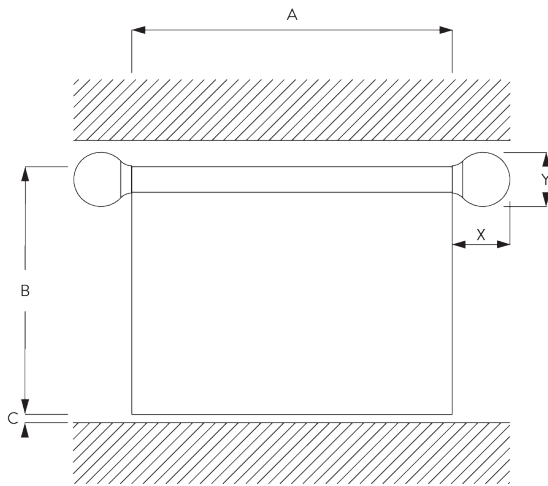

A: System width without finials









B: System height

C: Distance between floor and fabric

X: Finial width

Y: Finial height

Finial Measurements

		30 mm	
		X	Y
	SG 11603	2	30
	SG 11631	10	34
	SG 11632	18	50
	SG 11743	69	30
	SG 11744	66	50
	SG 11746	64	60
	SG 11747	116	48
	SG 11748	26	90
	SG 11749	20	60

C. SPECIFICATION

TEXT

Silent Gliss SG 7610 'Metropole' hand operated curtain track system. Comprises 30 mm aluminium profile SG 6103 supplied made to measure with 2C gliders SG 11300 at 14/m, 2 no. flush end covers SG 11603 and 2 no. end stops SG 6065. Straight poles supplied as standard with wall 'face' fix Smart Fix brackets SG 11206 at max. 600 mm centres. Optional wall fix brackets SG 11207-11208 / SG 11216-11218 / SG 11209 / SG 11472 / Fillet bracket SG 11669. Bent systems for wall 'face' fix supplied as standard with adjustable Smart Fix bracket SG 11209. Ceiling 'top' fix with plate SG 6151 / bracket SG 6175 / SG 11668 at max. 600 mm centres. Finished in Ecru, Bronze, Antique Bronze, Gunmetal, Black, Charcoal, Anodic Grey, Slate Grey, Matt White, White, Sand, Ochre, Chrome Effect, Anodised Silver or Taupe. A range of decorative finials are available (limited range for Silver Anodised and Chrome). Silent Gliss Wave option is available using 60mm glider cord SG 11303 / 80 mm glider cord SG 11302 / 80 mm roller glider cord SG 6099.

FITTING

A. FITTING INFORMATION

Fixing points

For detailed fitting information, visit the [Silent Gliss website](#).

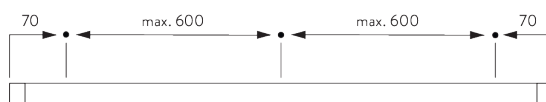

B. CEILING FITTING

Support SG 6151

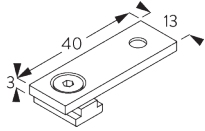
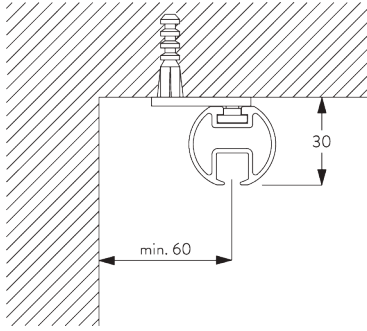

SG 6151

Ceiling support set 3 mm

Top fix bracket SG 11668

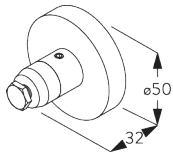
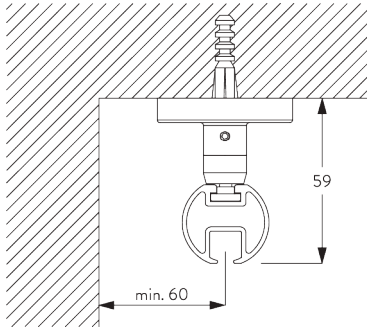

SG 11668

Top fix bracket

Mini hanger SG 6175

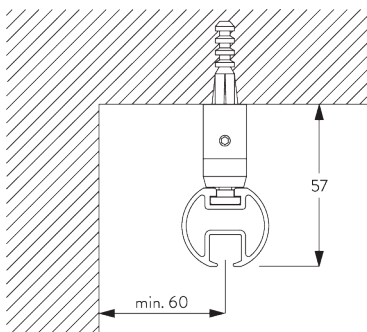

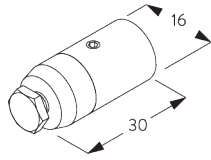

SG 6175

Mini hanger

C. WALL FITTING

Smart Fix

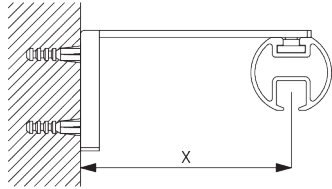

Smart Fix with slot SG 11206 - SG 11208 and SG 6141:
Screw SG 6783 (M4x10) needed.

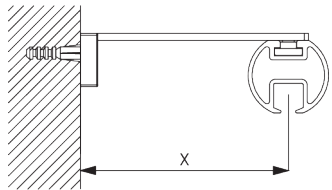

Square Smart Fix with slot SG 11216 - SG 11218 and SG 6141:
Screw SG 6783 (M4x10) needed.

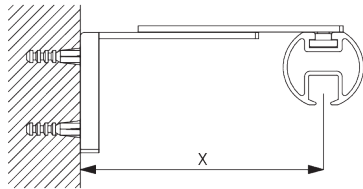

Adjustable Smart Fix SG 11209 and SG 6141:
Screw SG 6784 (M4x8) needed.

Note: all bent Metropole systems are supplied with adjustable bracket SG 11209 as standard.

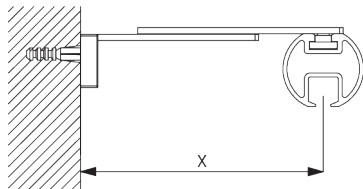

Adjustable Square Smart Fix SG 11472 and SG 6141:
Screw SG 6784 (M4x8) needed.

Smart Fix	X mm	Y mm	Z mm
SG 11206 / SG 11216	51		
SG 11207 / SG 11217	71		
SG 11208 / SG 11218	91		
SG 11209 / SG 11472	80-100		
SG 11154	102-130		
SG 11155	132-160	68	65-72
SG 11156	182-210	68	65-123

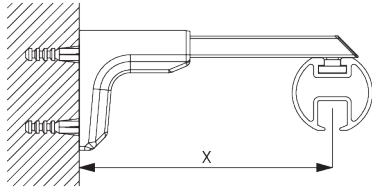

Universal Smart Fix SG 11154 - SG 11156 and SG 6141:

Screw SG 11131 (M4x6) needed.

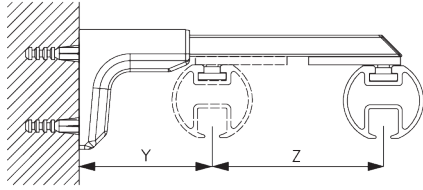

Double System:

Universal Smart Fix SG 11155 - SG 11156 and SG 6151:

Screw SG 11127 (M4x10) and nut SG 11148 needed

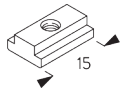

SG 6141

Clamping piece

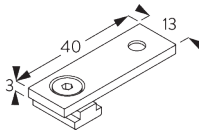

SG 6151

Ceiling support set 3 mm



SG 6783

Hexagon socket countersunk screw M4x10 mm



SG 6784

Hexagon socket countersunk screw M4x8 mm



SG 11127

Countersunk head screw M4x10



SG 11131

Pan head screw with flange M4x6



SG 11148

Nut

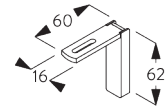

SG 11206

Smart Fix with slot 60 mm

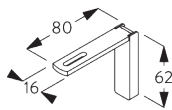

SG 11207

Smart Fix with slot 80 mm

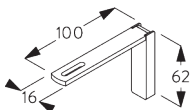

SG 11208

Smart Fix with slot 100 mm

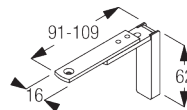

SG 11209

Adjustable Smart Fix

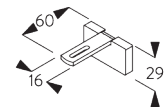

SG 11216

Square Smart Fix with slot 60 mm

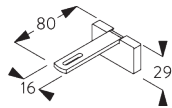

SG 11217

Square Smart Fix with slot 80 mm

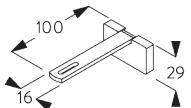

SG 11218

Square Smart Fix with slot 100 mm

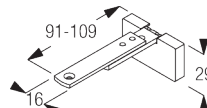

SG 11472

Adjustable Square Smart Fix

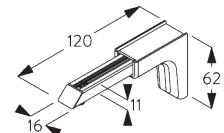

SG 11154

Universal Smart Fix 120 mm

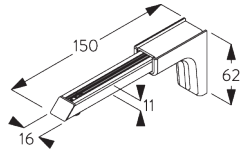

SG 11155
Universal Smart Fix 150 mm

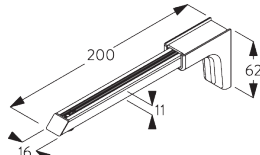

SG 11156
Universal Smart Fix 200 mm

Fillet Bracket SG 11669

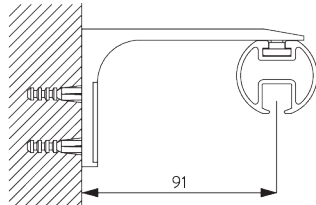

Screw SG 6784 (M4x8) needed.
Recommended for straight systems only.

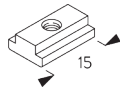

SG 6141
Clamping piece



SG 6784
Hexagon socket countersunk
screw M4x8 mm

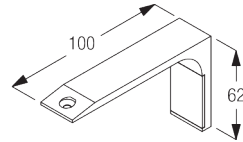

SG 11669
Fillet bracket

DESIGN & SYSTEM OPTIONS

A. ENDCAPS



SG 11603



SG 11631



SG 11632

Endcaps:

- SG 11603 Flush endcap 30 mm
- SG 11631 Stud endcap 30 mm
- SG 11632 Design endcap 30 mm

Please note:

- Without finials, poles are supplied as standard with flush fitting endcaps SG 11603 (left).
- Alternatively, stud endcaps SG 11631 can be selected at no additional cost.

B. FINIALS

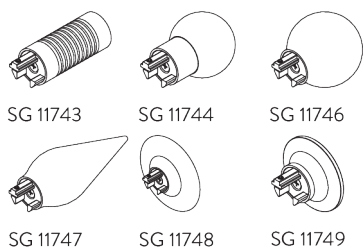

Finials are decorative elements that fit on at the end of the pole:

- SG 11743 Groove cylinder 30 mm
- SG 11744 Glass ball 30 mm
- SG 11746 Ball end 30 mm
- SG 11747 Spear 30 mm
- SG 11748 Ellipse 30 mm
- SG 11749 Taper 30 mm

C. WAVE

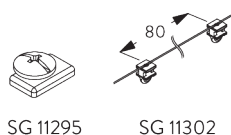
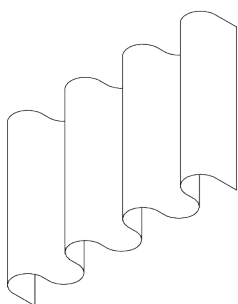

Standard components:

- SG 11295 End stop
- SG 11302 Wave 2C glider cord 80 mm

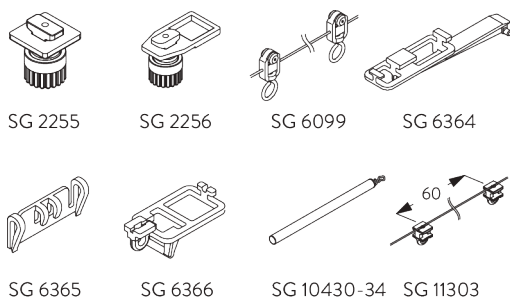

Optional components:

- SG 2255 Brake
- SG 2256 Brake
- SG 6099 Wave roller cord 80 mm
- SG 6364 Wave extension
- SG 6365 Wave hanger
- SG 6366 Wave carrier for draw rod
- SG 10430-34 Draw rod
- SG 11303 Wave 2C glider cord 60 mm

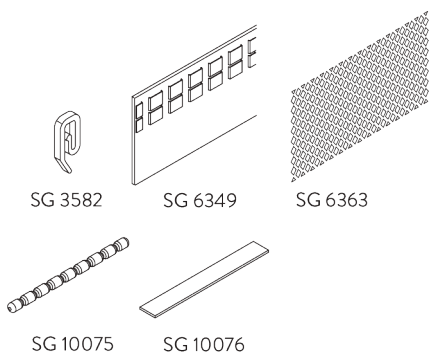

Curtain components:

- SG 3582 Hook
- SG 6349 Wave curtain tape
- SG 6363 Wave top hemming tape
- SG 10075 Lead weight 50 gr/m
- SG 10076 Fabric weigh

Wave stack depth - 2C glider cord (standard components)

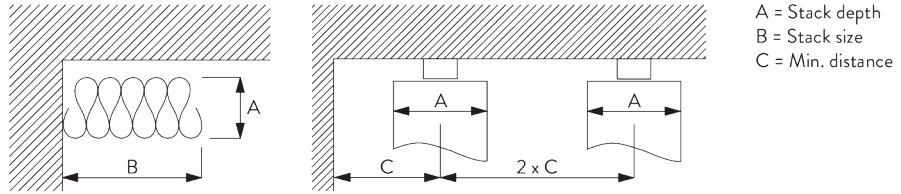

2C Glider cord SG 11302	Pockets between hooks	Approx. curtain fullness	Stack depth A	Stack size B*	Min distance C
80	6	~2.1	140	180 per metre of track	90
80	7	~2.3	160	180 per metre of track	100

2C Glider cord SG 11303	Pockets between hooks	Approx. curtain fullness	Stack depth A	Stack size B*	Min distance C
60	4	~2.1	100	230 per metre of track	70
60	5	~2.3	120	230 per metre of track	80

*Stack size B when using optional extension arm SG 6364 increases by 95 mm per curtain stack!

PARTS

A. STANDARD PARTS



SG 6065

End stop



SG 6103p

Profile



SG 6141

Clamping piece

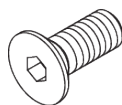

SG 6783

Hexagon socket countersunk screw
M4x10 mm

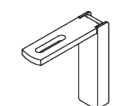

SG 11206

Smart Fix with slot 60 mm



SG 11300

2C glider

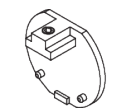

SG 11603

Flush end cap 30 mm

B. OPTIONAL PARTS

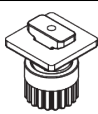

SG 2255

Brake

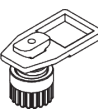

SG 2256

Brake



SG 3582

Hook

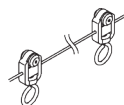

SG 6099

Wave roller cord 80 mm

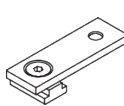

SG 6151

Ceiling support set 3 mm

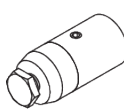

SG 6175

Mini hanger



SG 6283

Roller



SG 6349

Wave curtain tape



SG 6363

Wave top hemming tape

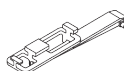

SG 6364

Wave extension

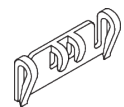

SG 6365

Wave hanger

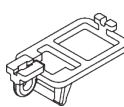

SG 6366

Wave carrier for draw rod

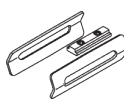

SG 6635

Connection bridge set

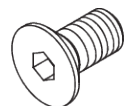

SG 6784

Hexagon socket countersunk screw
M4x8 mm

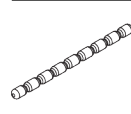

SG 10075

Lead weight 50 g/m

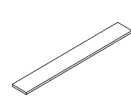

SG 10076

Fabric weight

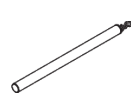

SG 10430

Draw rod 50 cm

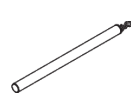

SG 10431

Draw rod 75 cm

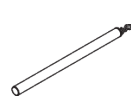

SG 10432

Draw rod 100 cm



SG 10433

Draw rod 125 cm

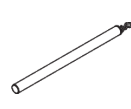

SG 10434

Draw rod 150 cm

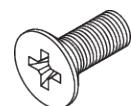

SG 11127

Countersunk head screw M4x10

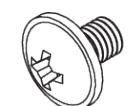

SG 11131

Pan head screw with flange M4x6



SG 11148

Nut

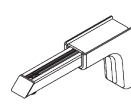

SG 11154

Universal Smart Fix 120 mm

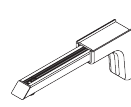

SG 11155

Universal Smart Fix 150 mm

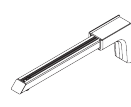

SG 11156

Universal Smart Fix 200 mm

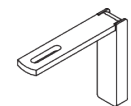

SG 11207

Smart Fix with slot 80 mm

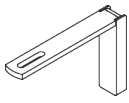

SG 11208
Smart Fix with slot 100 mm

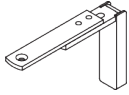

SG 11209
Adjustable Smart Fix

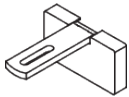

SG 11216
Square Smart Fix with slot 60 mm

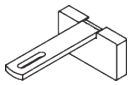

SG 11217
Square Smart Fix with slot 80 mm

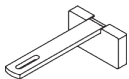

SG 11218
Square Smart Fix with slot 100 mm

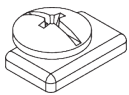

SG 11295
End stop



SG 11301
2C glider on strip

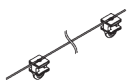

SG 11302
Wave 2C glider cord 80 mm

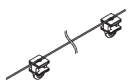

SG 11303
Wave 2C glider cord 60 mm

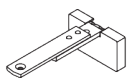

SG 11472
Adjustable Square Smart Fix



SG 11631
Stud endcap 30 mm

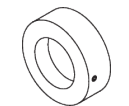

SG 11632
Design endcap 30 mm



SG 11668
Top fix bracket

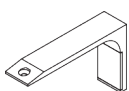

SG 11669
Fillet bracket

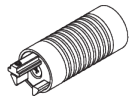

SG 11743
Groove cylinder 30 mm



SG 11744
Glass ball 30 mm



SG 11746
Ball end 30 mm

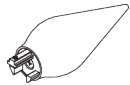

SG 11747
Spear 30 mm



SG 11748
Ellipse 30 mm



SG 11749
Taper 30 mm

