

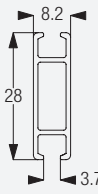







# Room Divider/Cubicle/ Shower Rail Systems



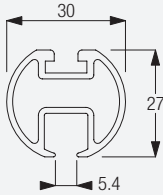

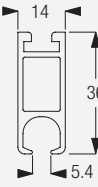
## Application Chart

Specification	Profile		Features / Options		Fitting Options			Fitting Surfaces			System			
	Weight Range	Profile Number	Dimensions in mm	Gliding Channel (mm)	Standard Bending Radius (mm)	Safety Device Option	Shower Rail only	Ceiling Fix	Wall Fix	Fitting with Hanger Rods		Wood	Concrete	Suspended ceiling
	1085		3.7	200	●		●	●	●	●	●	●	●	1085
	6101		5.4	200			●	●	●	●	●	●	●	6100
	6103		5.4	300			●	●	●	●	●	●	●	6103
	6101		5.4	300	●			●	●	●	●	●	●	6650

 Sliding panel systems can also be used for room dividing. Please refer to the Sliding Panel Systems section of the catalogue for further information.

 Light-weight applications

 Medium-weight applications

 Heavy-duty applications

## Standard shapes and sizes as shower rail (1085/6100 and 6103 Systems)

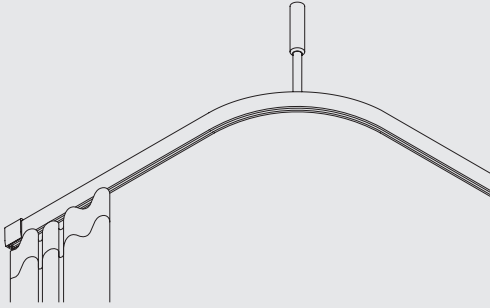

6100/6103 can also be custom shaped for special baths.  
Both are available in silver anodised finish.  
6103 is also available in chrome and anodised gold finished.

### Model A

91cm, 183cm, 213cm, 244cm



### Model B

76cm x 76cm, 91cm x 91cm



Model C – left  
Model D – right  
168cm x 76cm



### Model E

91cm x 76cm x 91cm

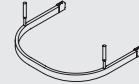

[www.silentgliss.co.uk](http://www.silentgliss.co.uk)

[www.silentglissglobal.com](http://www.silentglissglobal.com)

Silent Gliss Ltd  
Pyramid Business Park  
Poorhole Lane  
Broadstairs  
Kent  
CT10 2PT  
Great Britain

Tel: +44 (0) 1843 863571  
Fax: +44 (0) 1843 864503  
[info@silentgliss.co.uk](mailto:info@silentgliss.co.uk)

Silent Gliss Global Ltd  
Pyramid Business Park  
Poorhole Lane  
Broadstairs  
Kent  
CT10 2PT  
Great Britain

Tel: +44 (0) 1843 874250  
Fax: +44 (0) 1843 874457  
[info@silentglissglobal.com](mailto:info@silentglissglobal.com)